

# VEX IQ

## Инструкция по сборке V-Rex

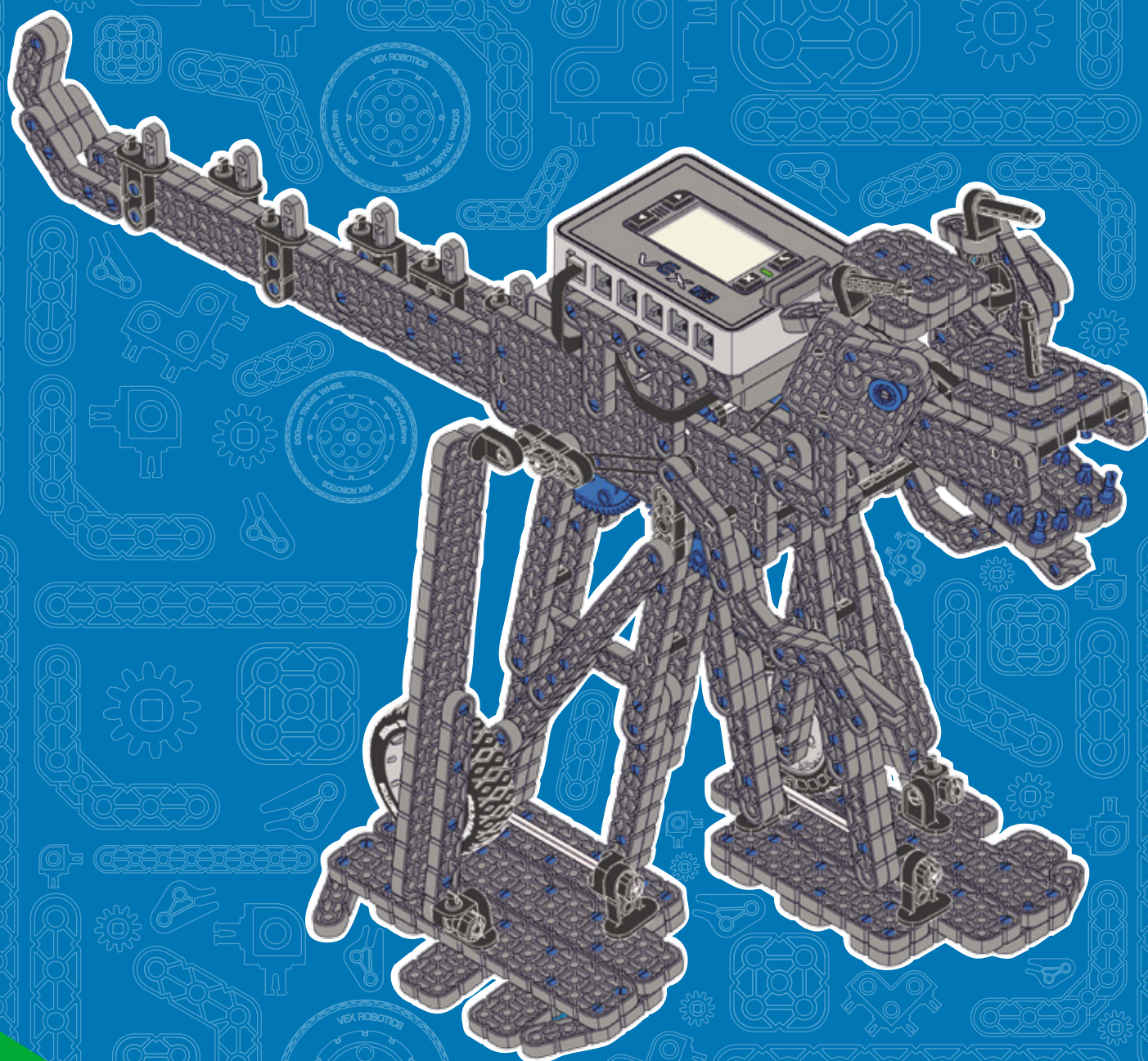

# Оглавление

**Полезные советы** ..... 3

**1 Сборка Ike** ..... 4

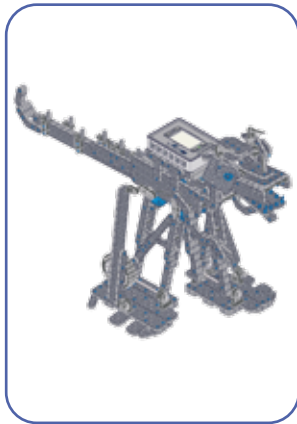

**Пошаговая инструкция 1-118**

**2 Руководство по управлению** ..... 35

# Полезные советы

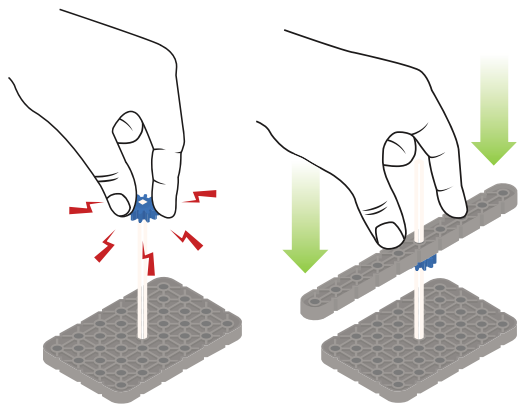

Используйте 1x планку при установке маленьких деталей VEX IQ на вал.

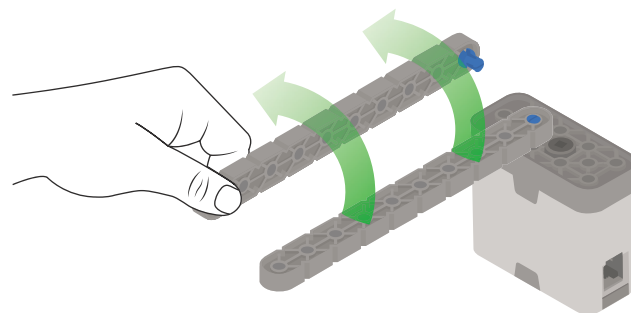

Соединительные штифты могут быть аккуратно сняты с моторов, сенсоров или микроконтроллера с помощью 1x планки. Установите планку на штифт и в процессе снятия – поверните ее.

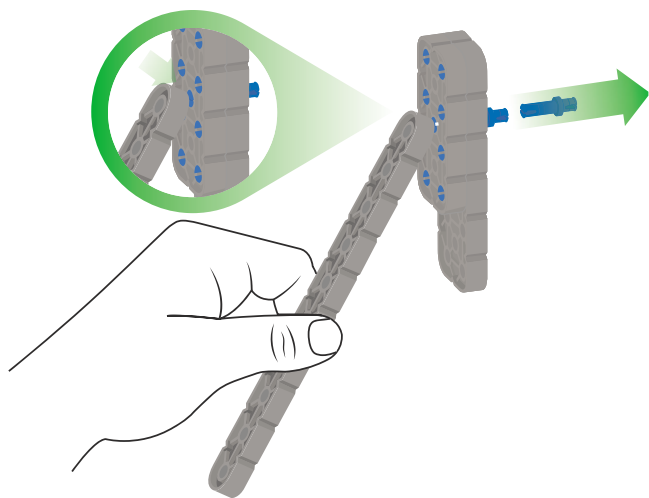

Для простого отсоединения соединительного штифта нажмите на его заднюю часть 1x планкой.

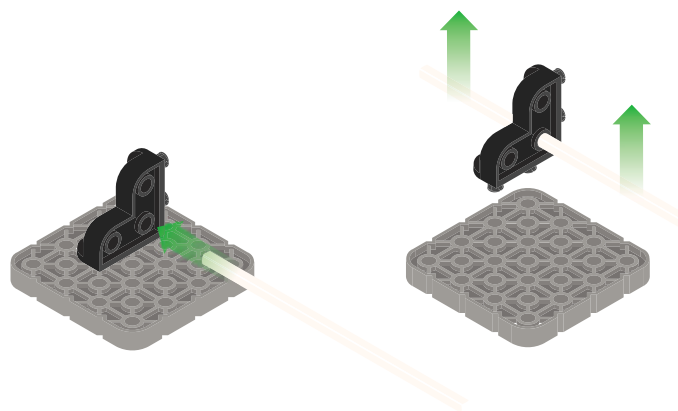

Для простого отсоединения угловых соединительных элементов поместите вал в одно из отверстий элемента и потяните.

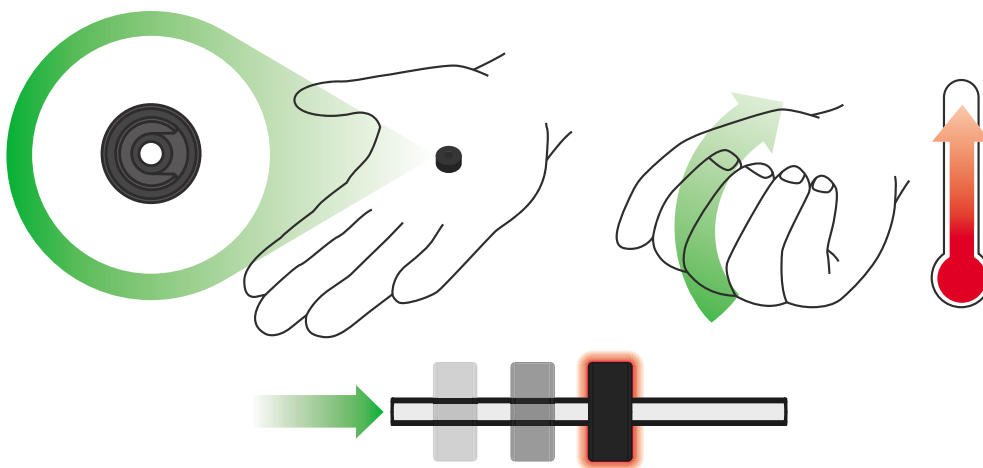

Резиновые кольца для вала становятся более мягкими и гибкими (для более простой установки на вал) если их нагреть, подержав в руке 15-30 секунд.

# 1. Сборка V-Rex

1

Используемые детали

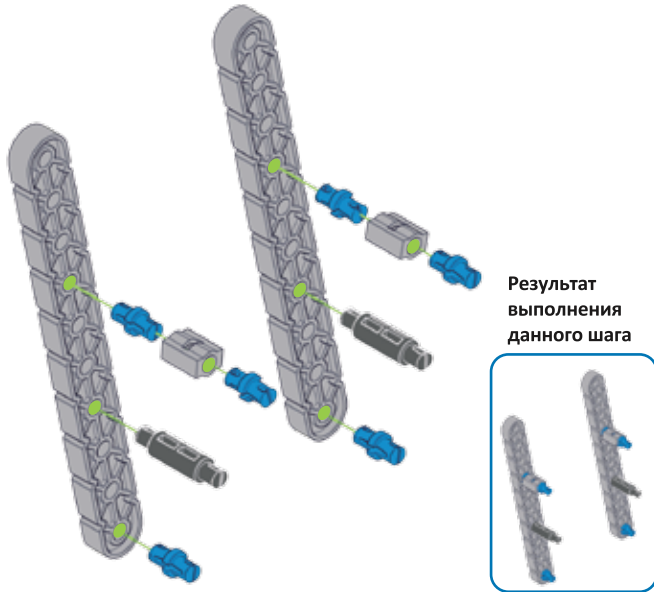
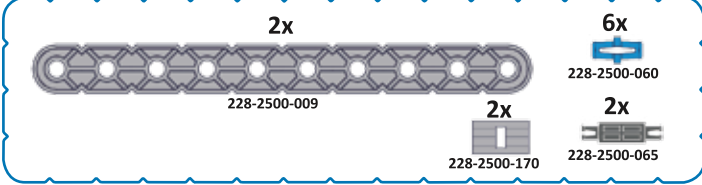

2

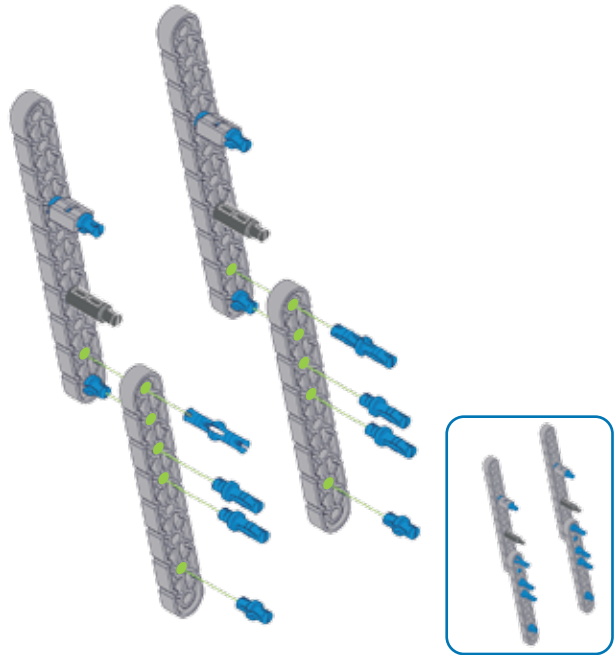
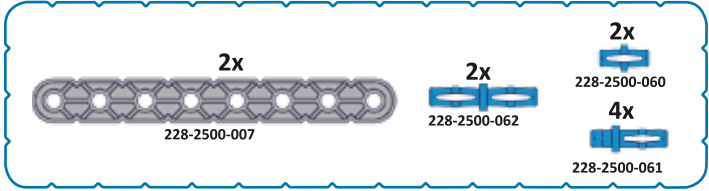

3

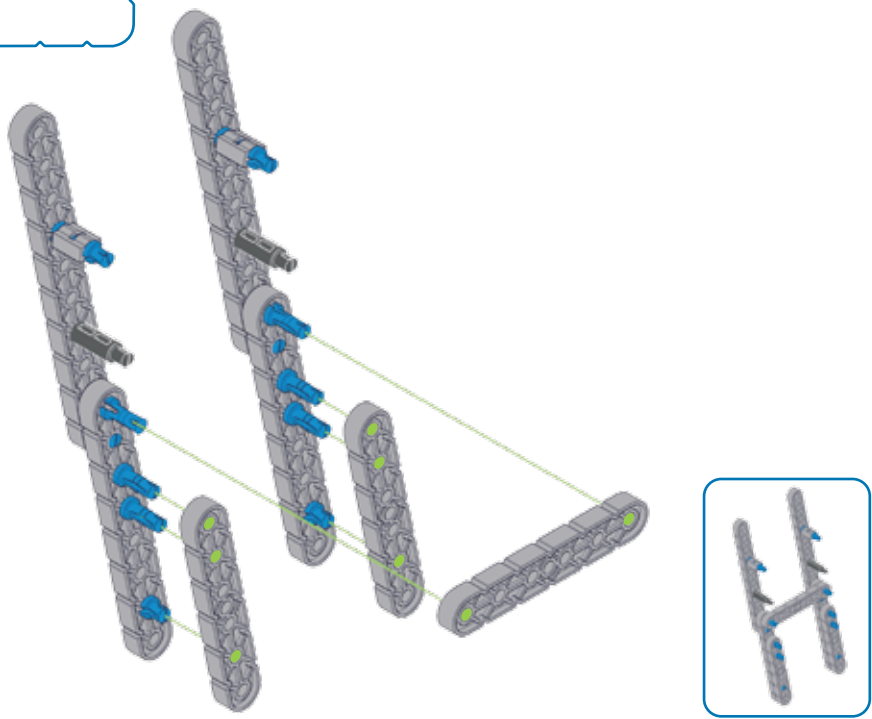
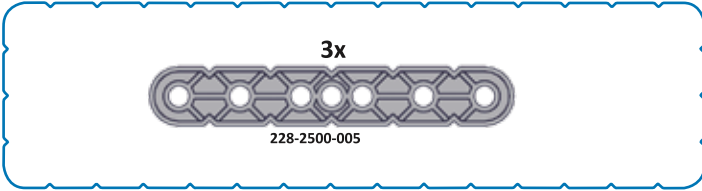

4

1x 228-2500-082  
 1x 228-2500-120  
 2x 228-2500-141  
 2x 228-2500-112  
 1x 228-2500-143

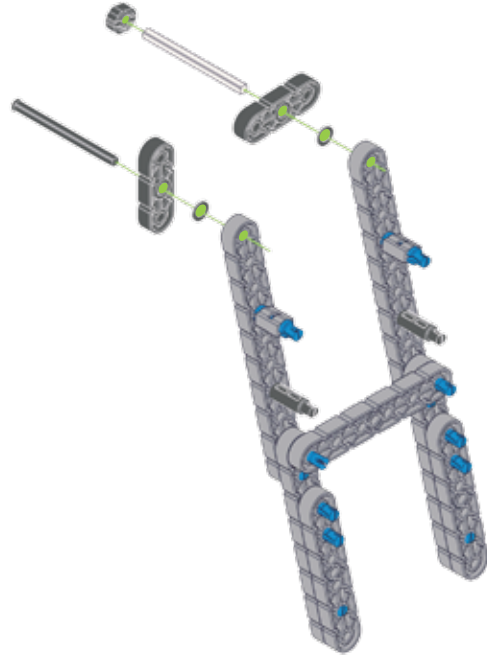
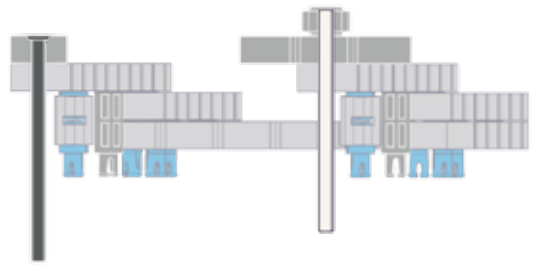

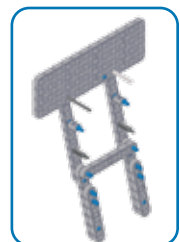
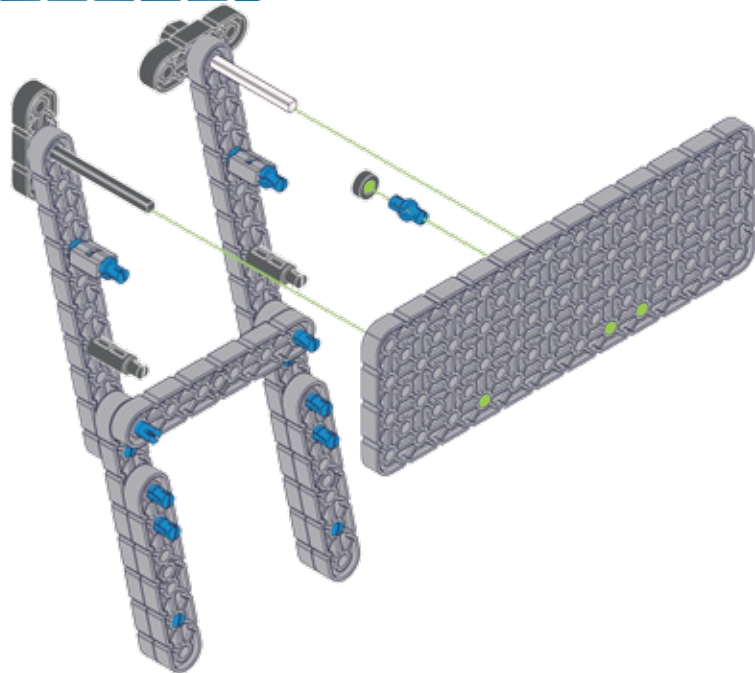

5

1x 228-2500-045  
 1x 228-2500-060  
 1x 228-2500-114



6

2x  228-2500-215

2x  228-2500-112

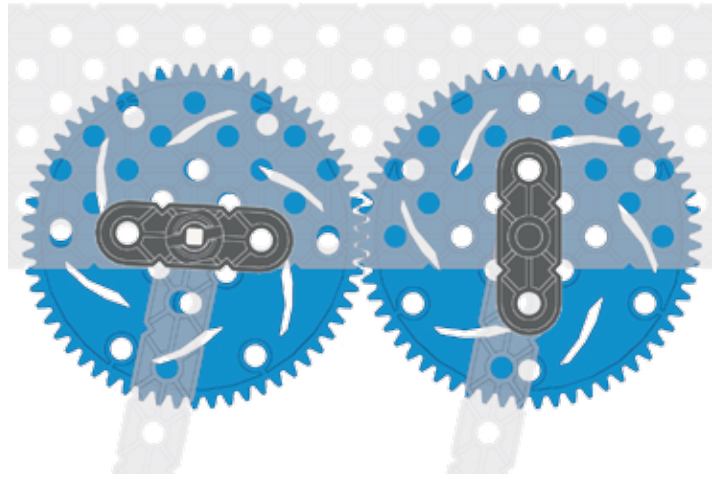
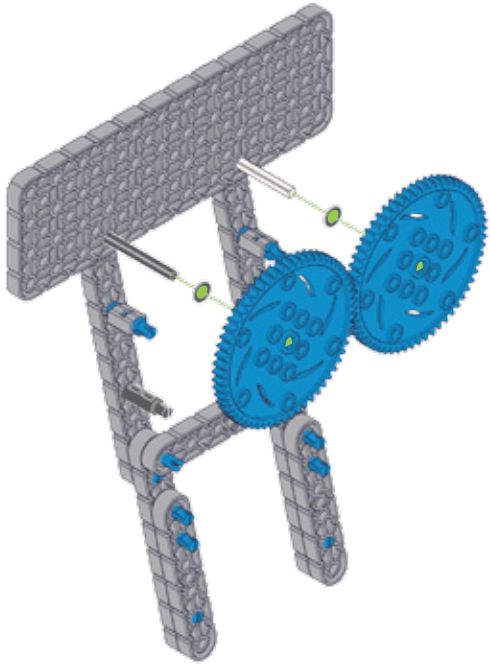

Убедитесь, что отверстия деталей 228-2500-141 и 228-2500-215 находятся в положении, как на рисунке.

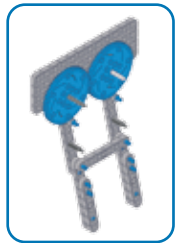

7

2x  228-2500-011

2x  228-2500-112

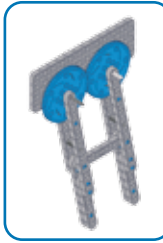
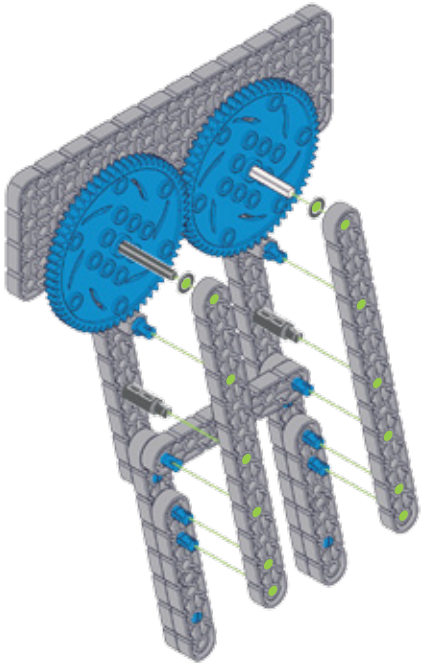



8

1x  228-2500-026

1x  228-2500-061

3x  228-2500-060

2x  228-2500-065

2x  228-2500-170

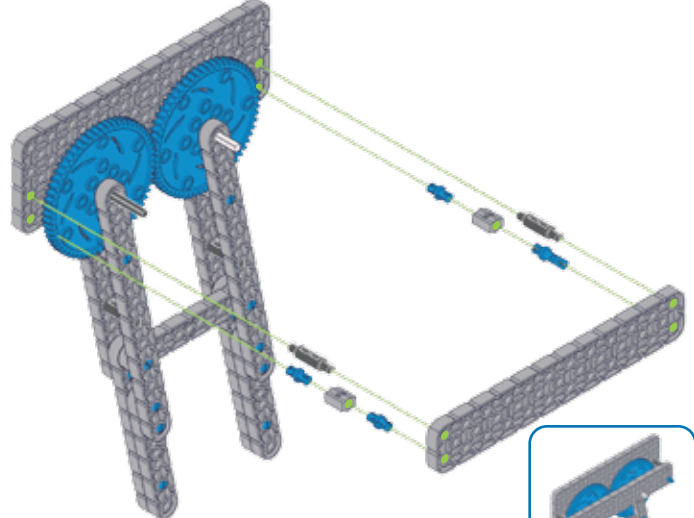

9

2x  
228-2500-143

1x  
228-2500-164

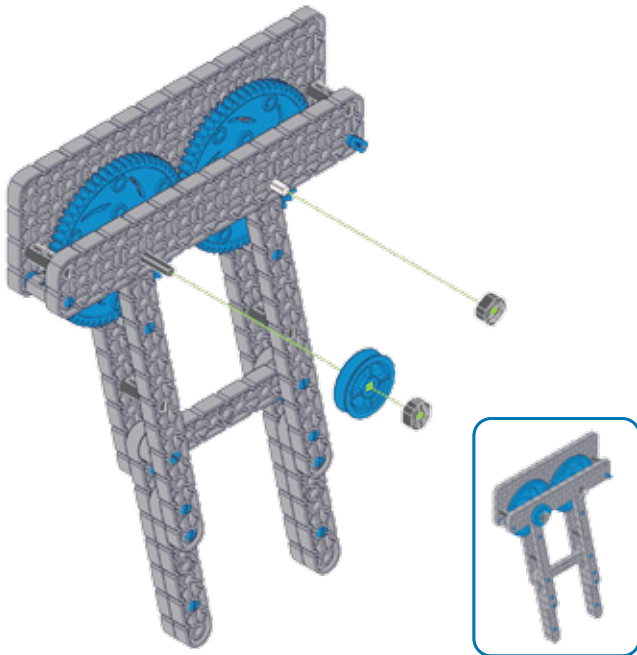

10

4x  
228-2500-067

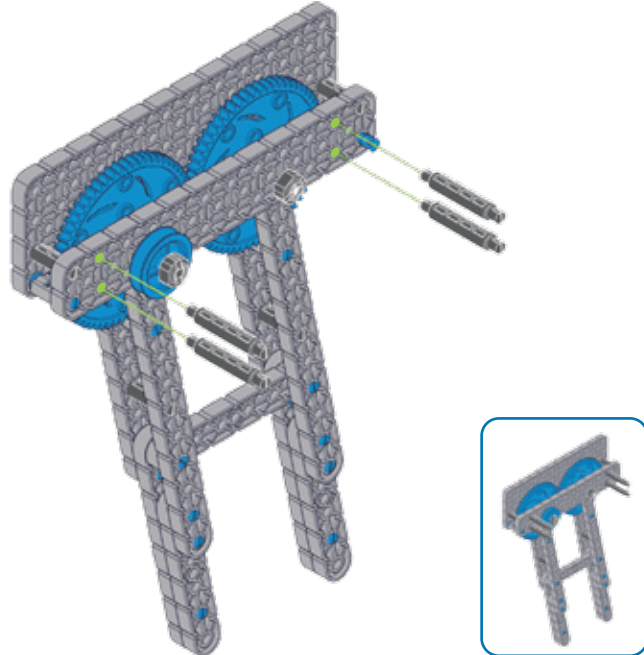

11

2x  
228-2500-070

2x  
228-2500-170

2x  
228-2500-060

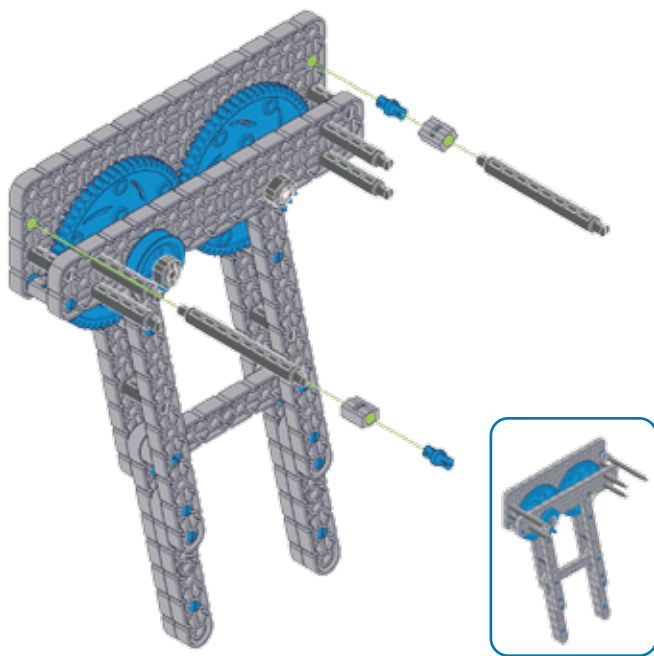

12

1x  
228-2500-019

1x  
228-2500-151

1x  
228-2500-061

1x  
228-2500-060

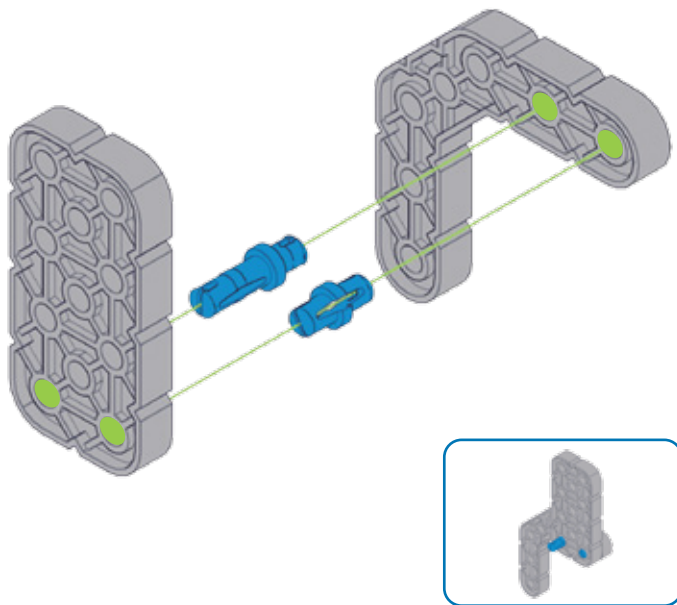

13

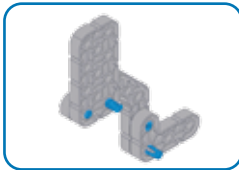
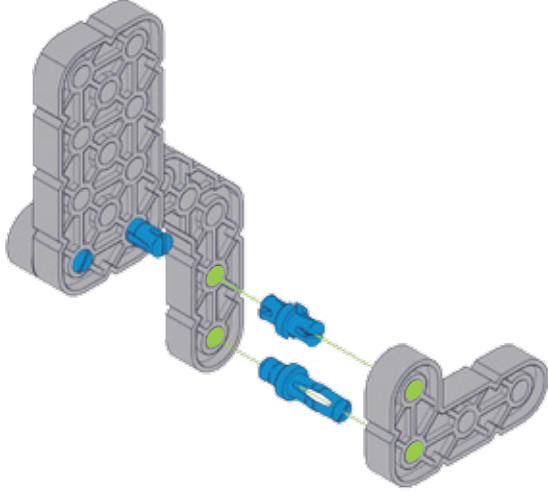
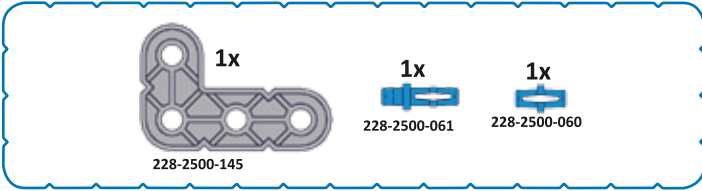

14

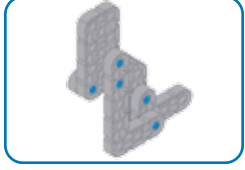
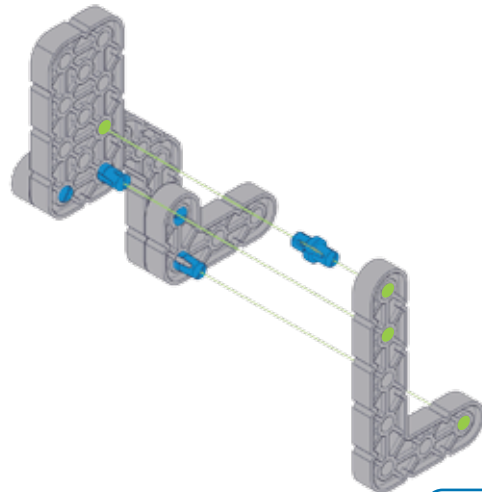
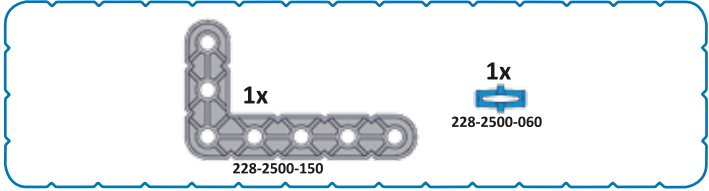

15

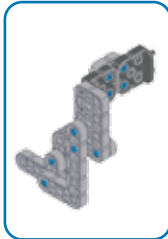
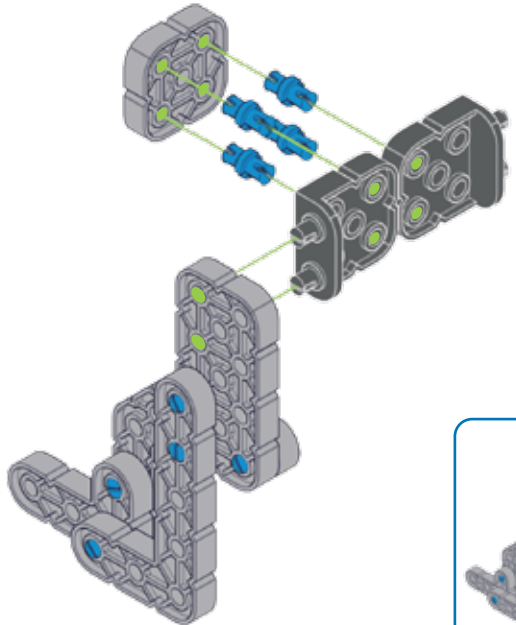
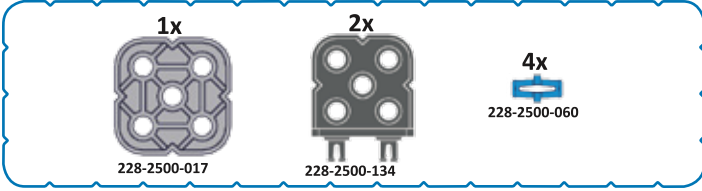

16

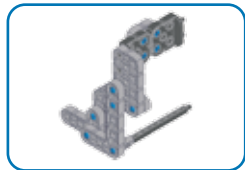
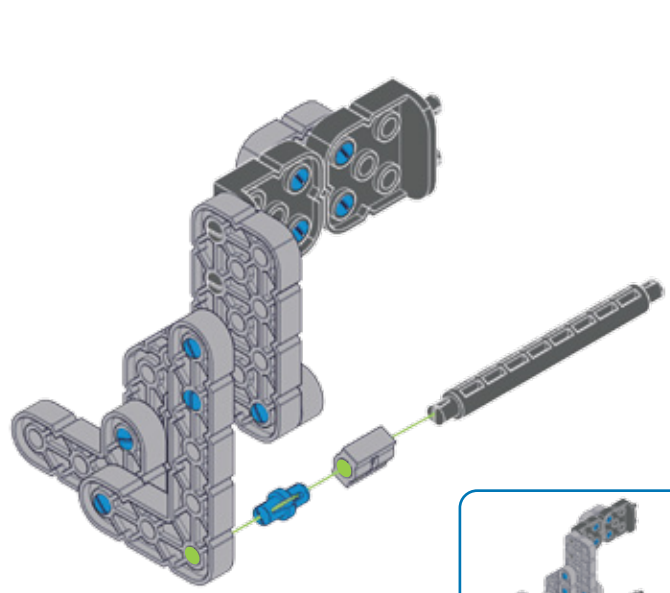
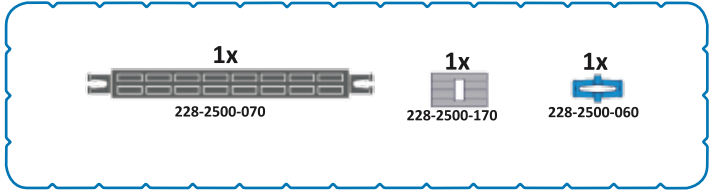



17

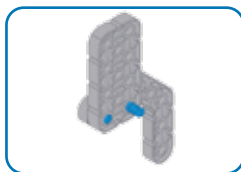
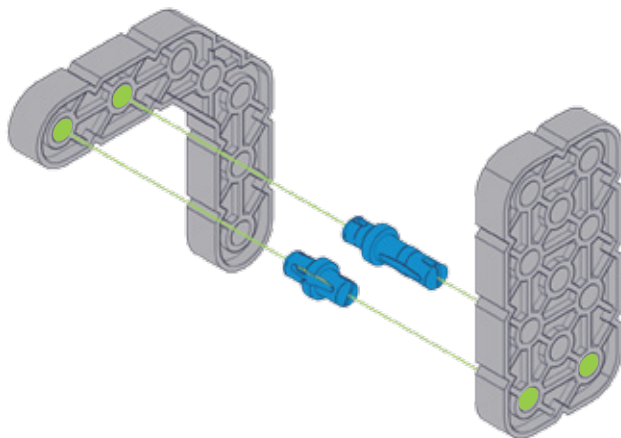
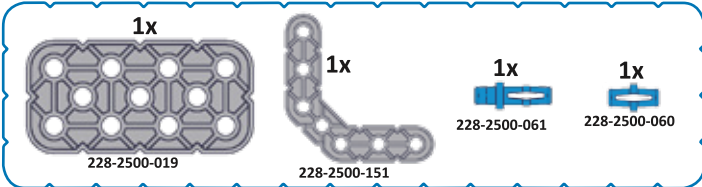

18

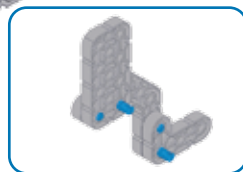
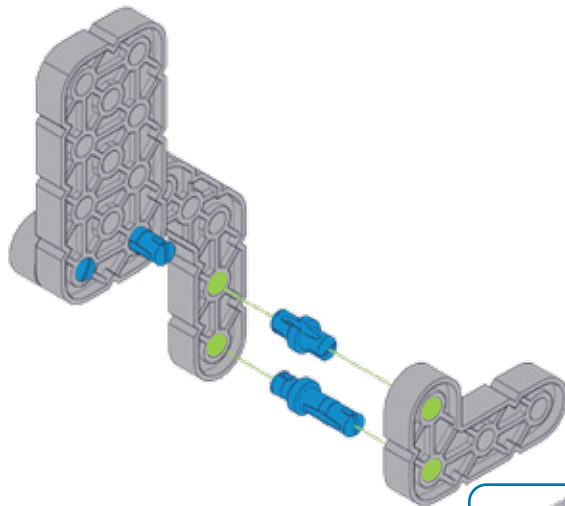
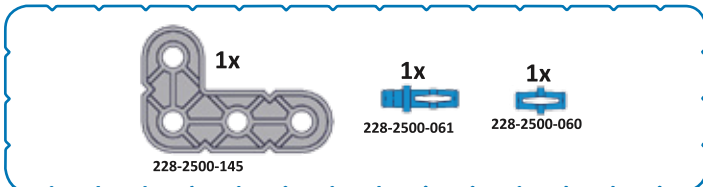

19

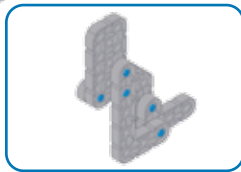
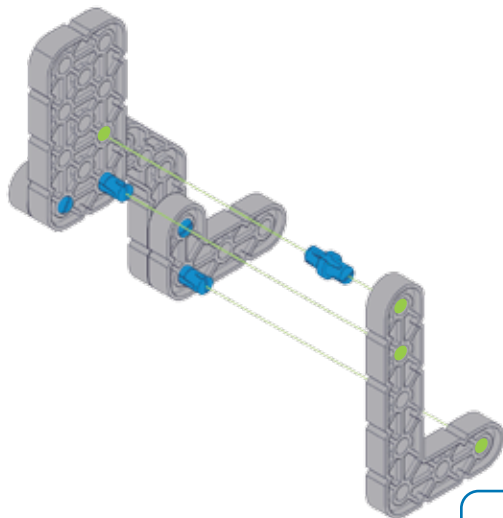
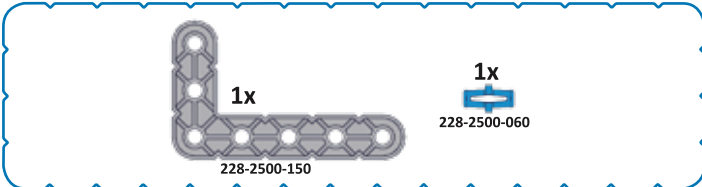

20

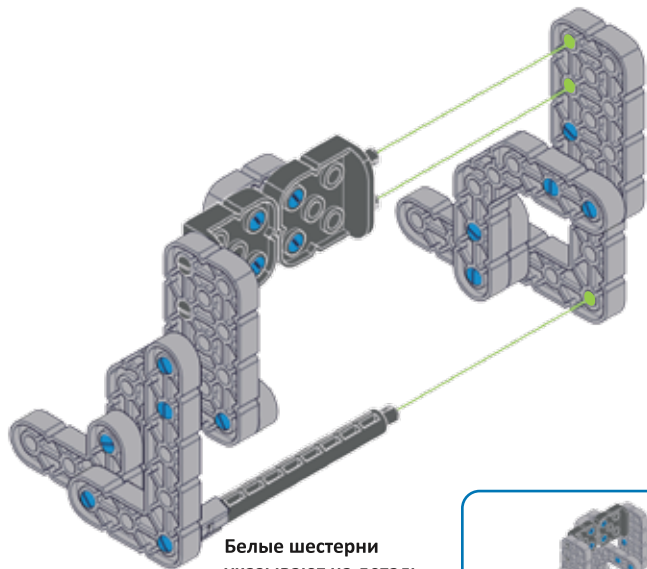
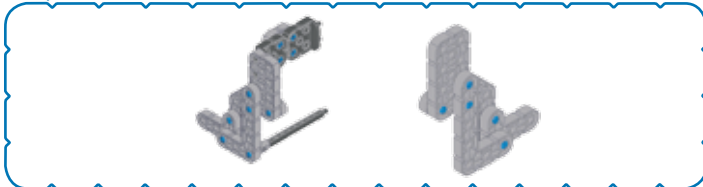

Белые шестерни указывают на деталь из предыдущих шагов:

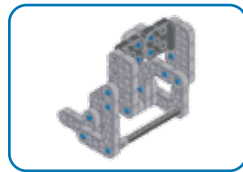

21

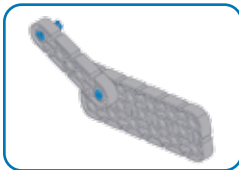
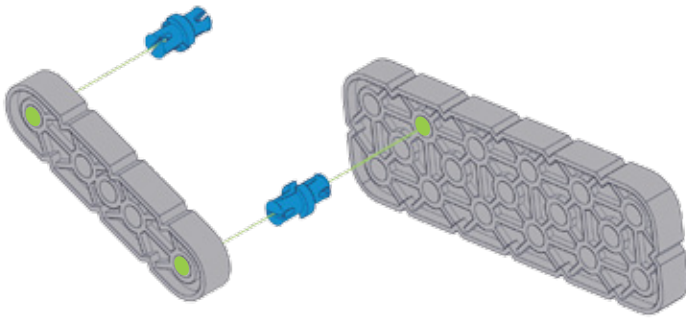
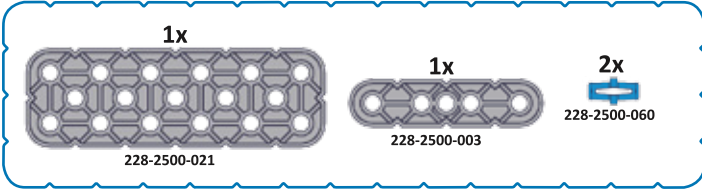

22

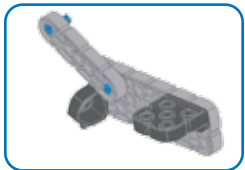
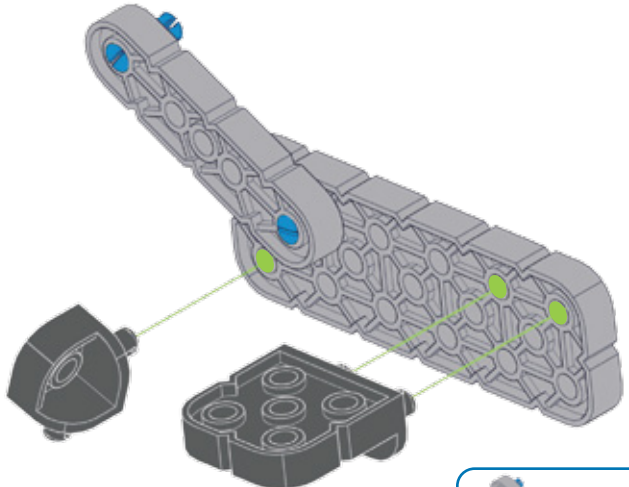
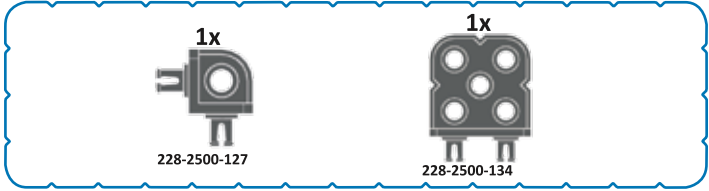

23

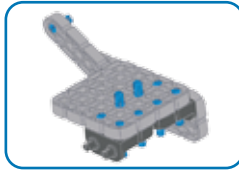
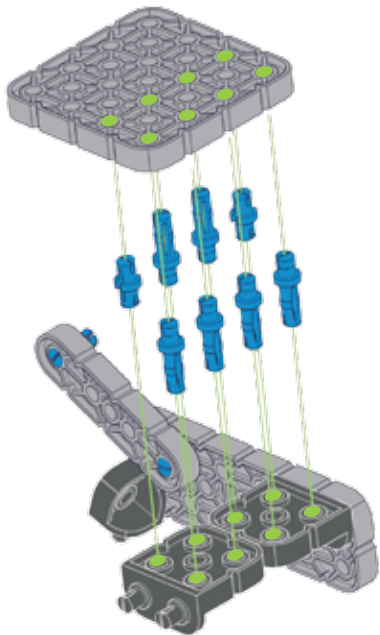
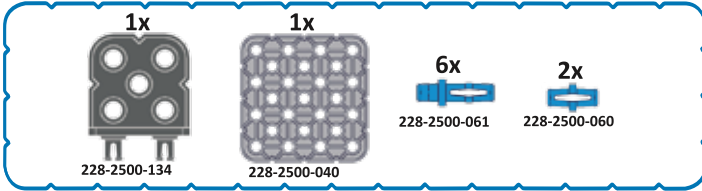

24

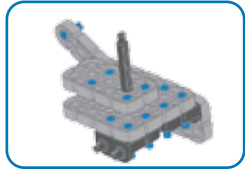
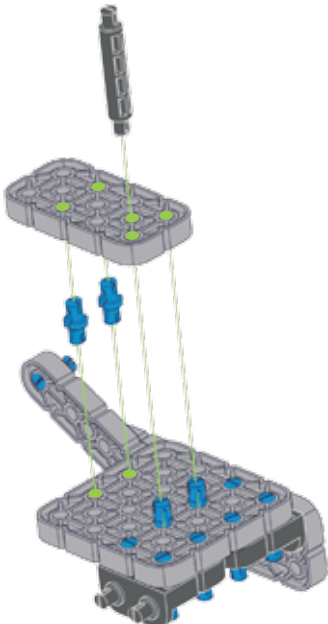
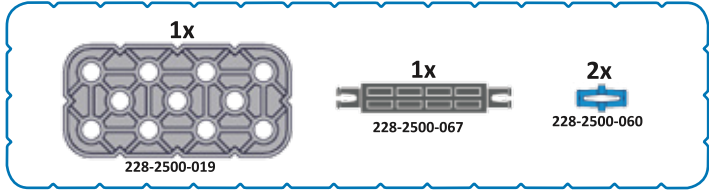

25

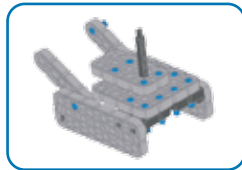
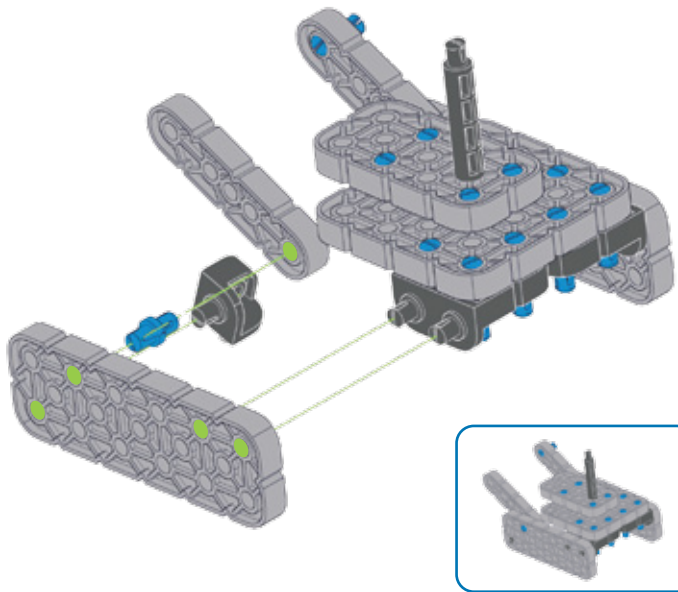
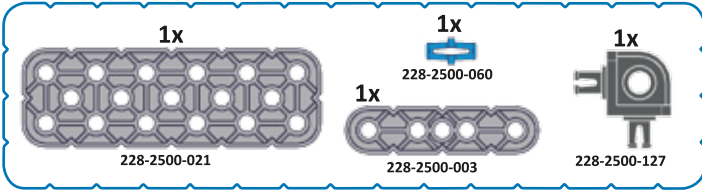

26

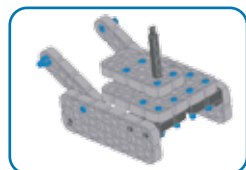
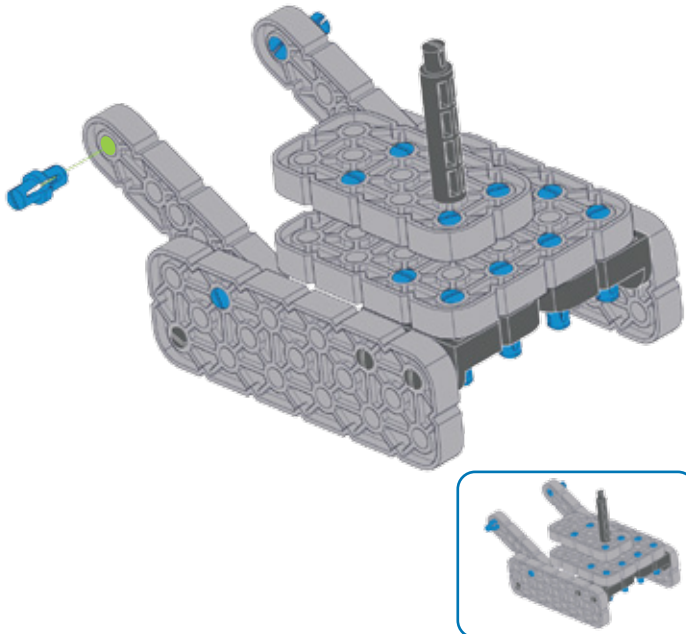
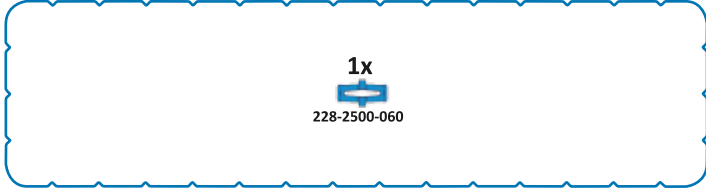

27

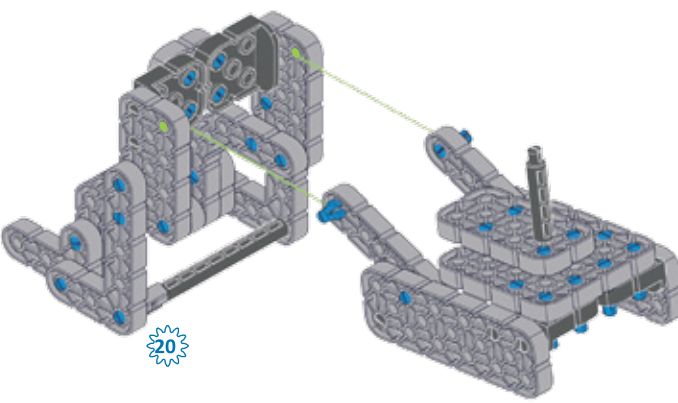
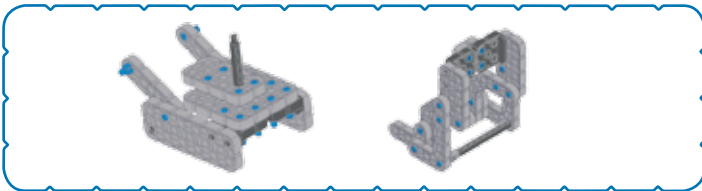

20

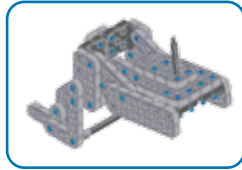

28

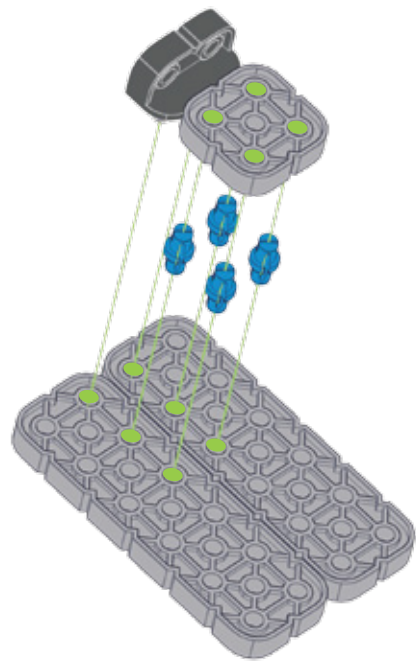
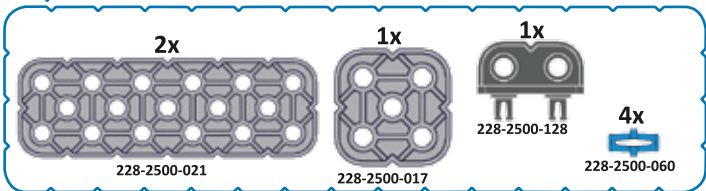

29

8x  
228-2500-060

2x  
228-2500-061

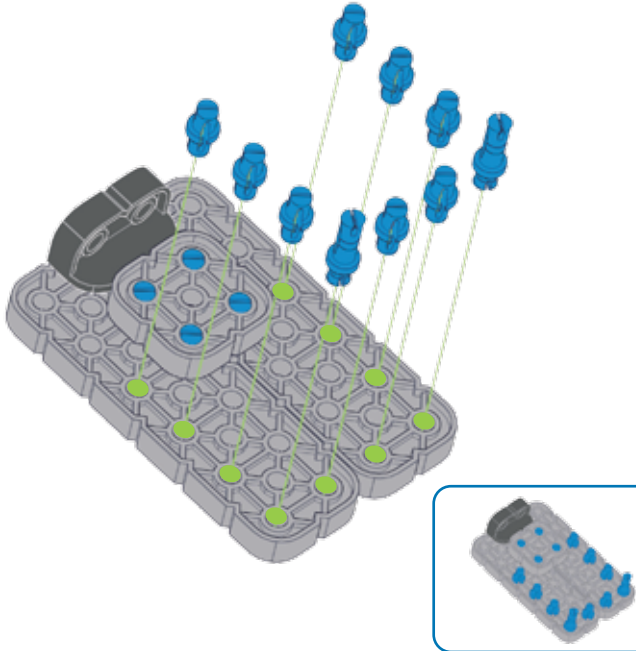

30

1x  
228-2500-130

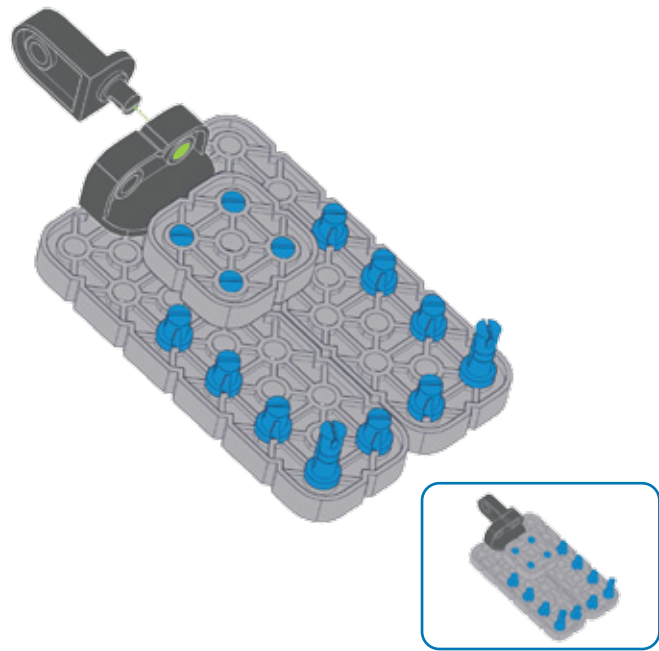

31

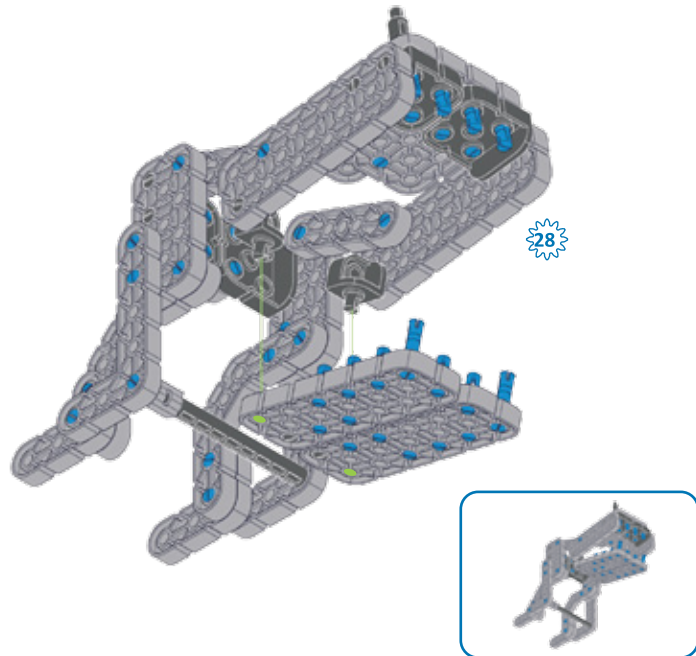
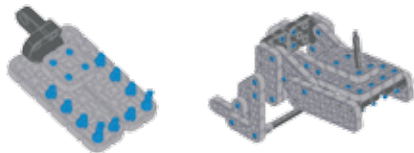

32

2x  
228-2500-127

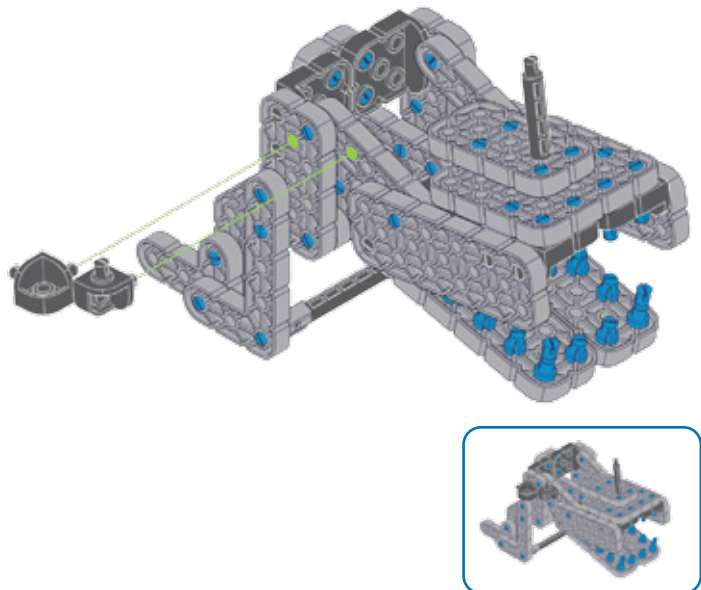

33

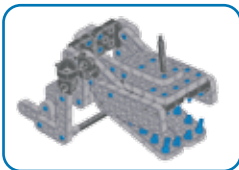
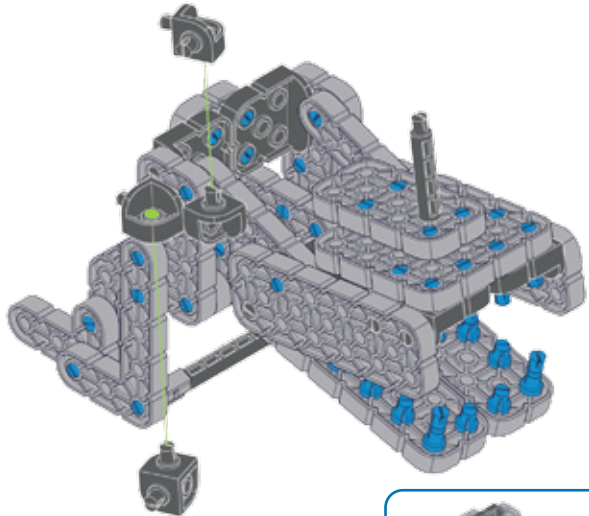
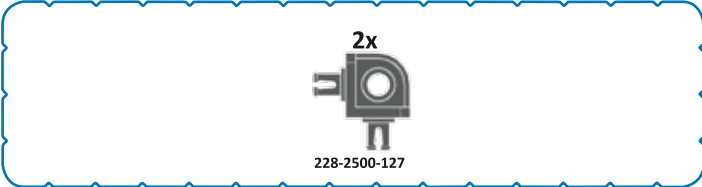

34

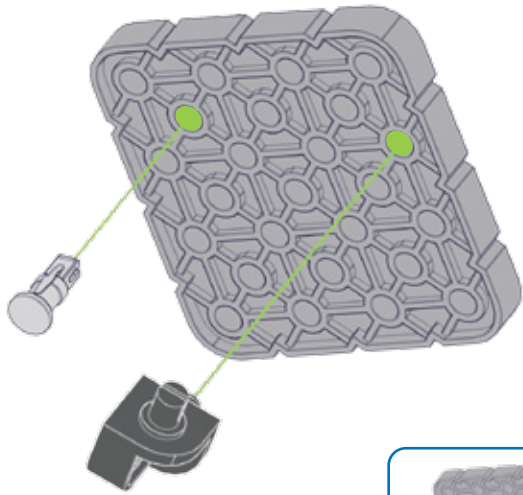
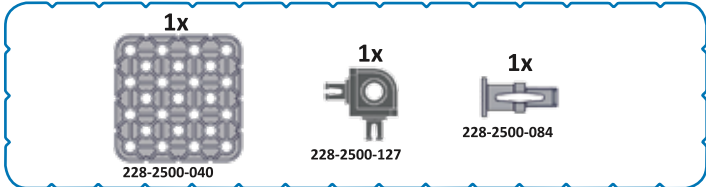

35

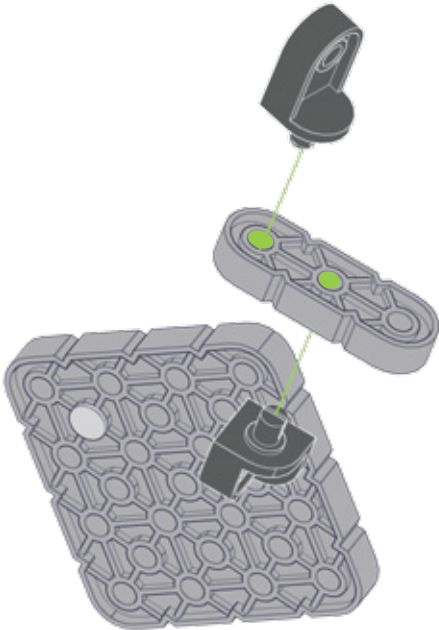
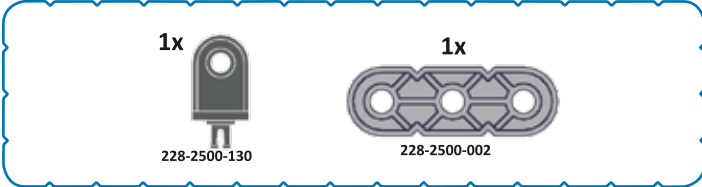

36

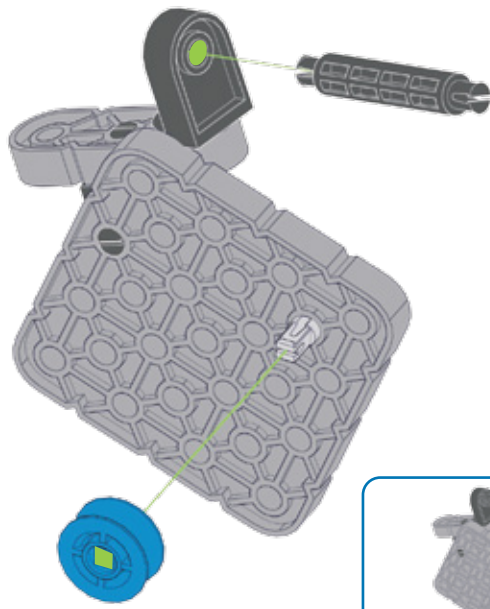
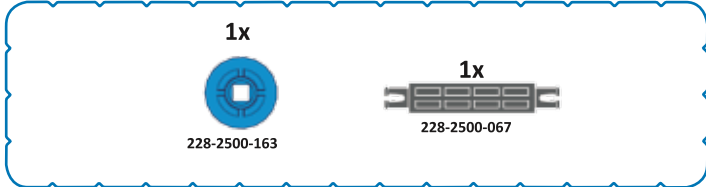

37

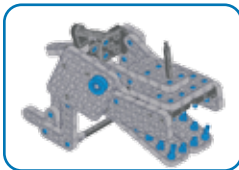
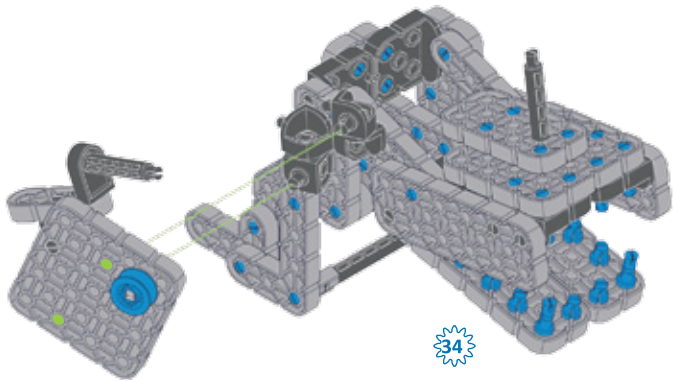
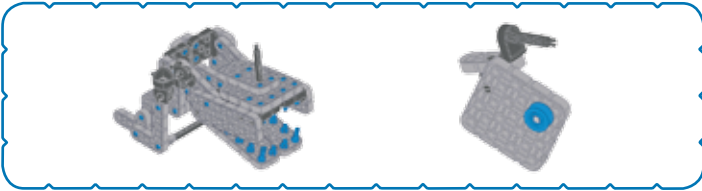

38

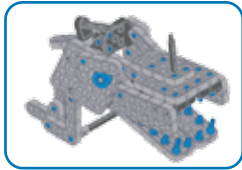
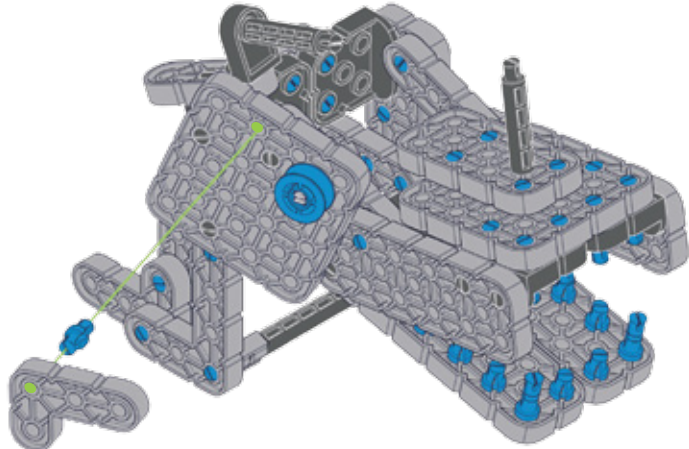
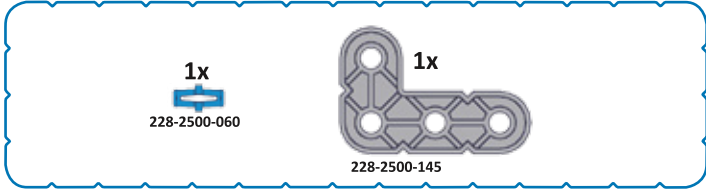

39

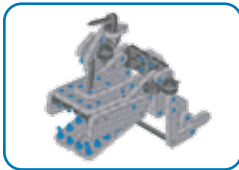
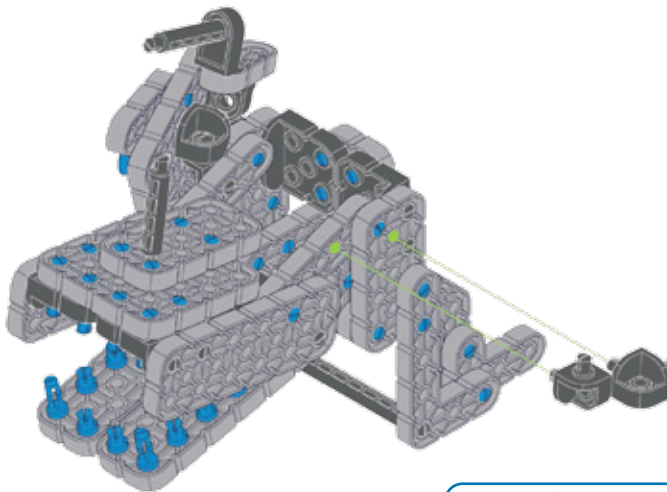
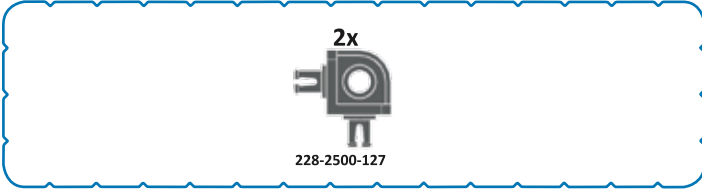

40

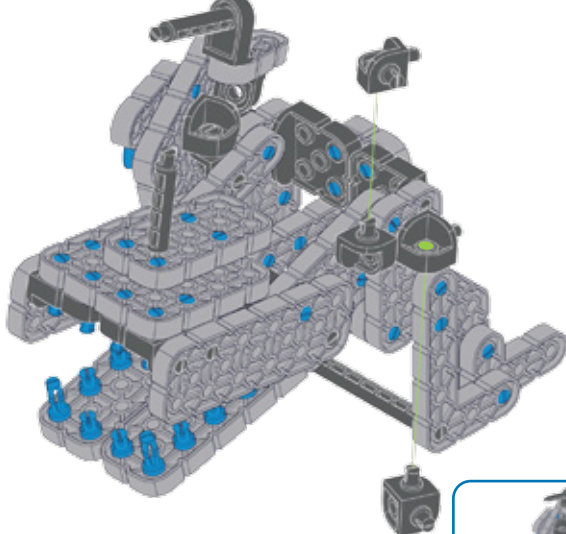
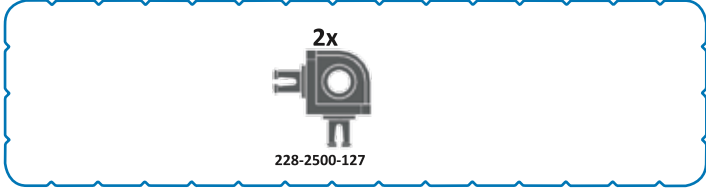

41

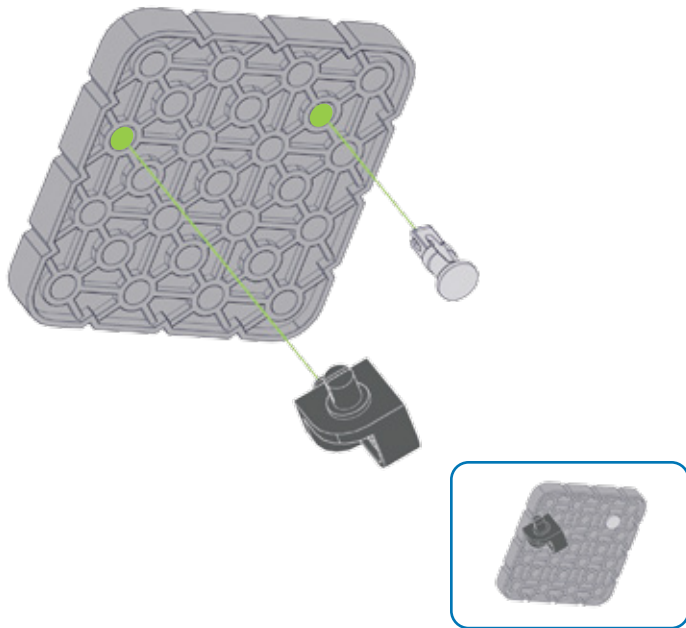
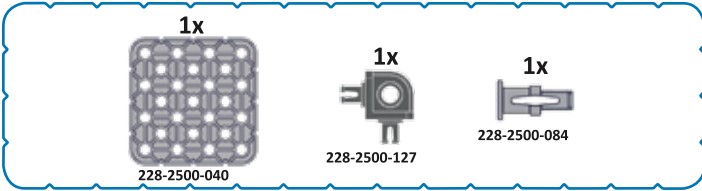

42

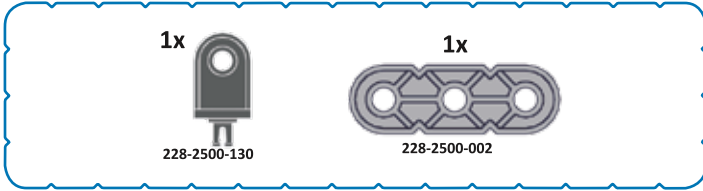

43

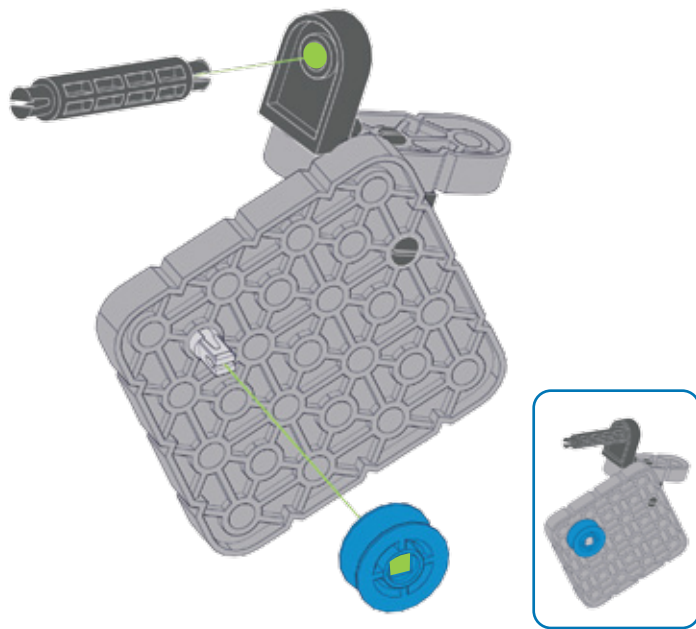
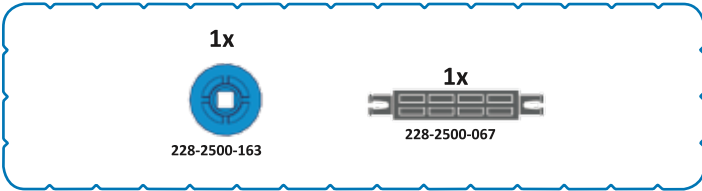

44

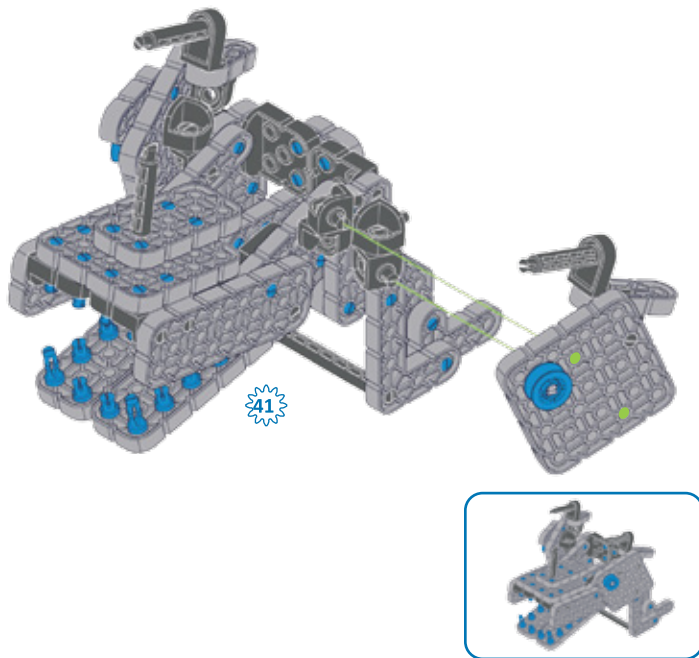
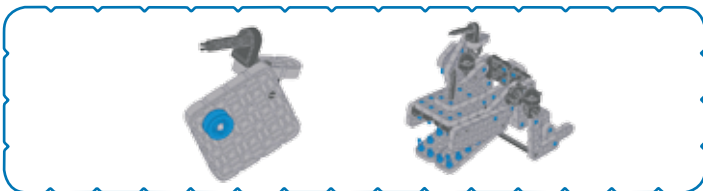

45

1x  
228-2500-060

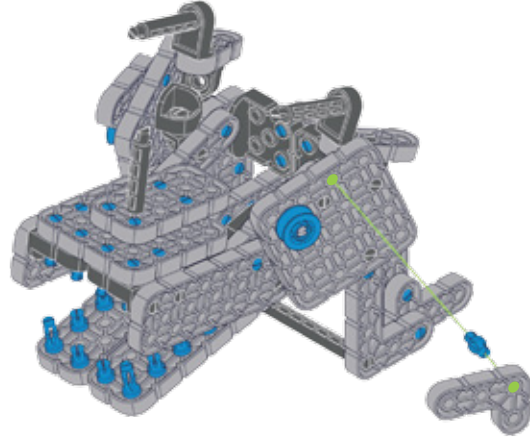
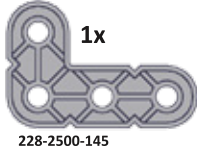

46

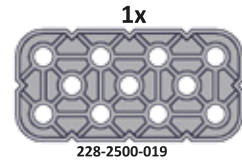
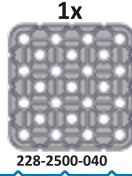

3x  
228-2500-060

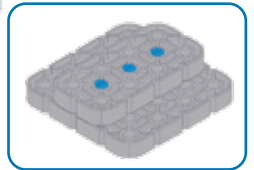
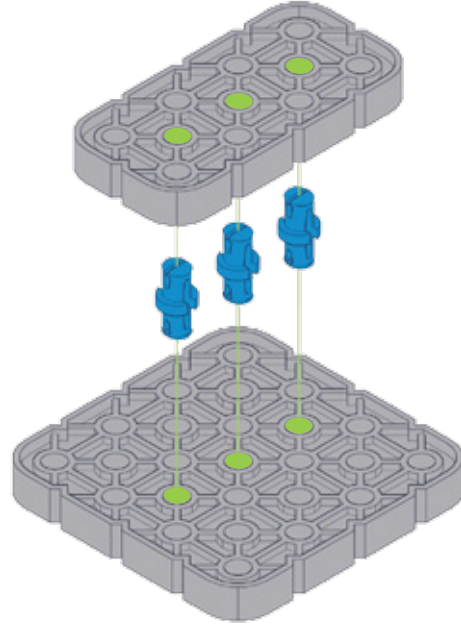

47



2x  
228-2500-130

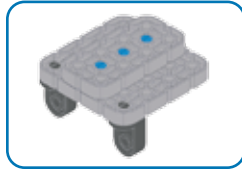
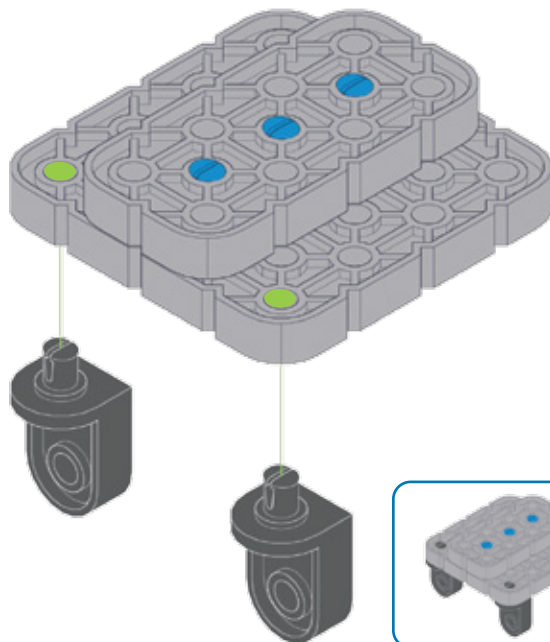

48



2x  
228-2500-060





49

1x  228-2500-165

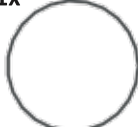
1x  228-2500-224

1x  228-2500-084

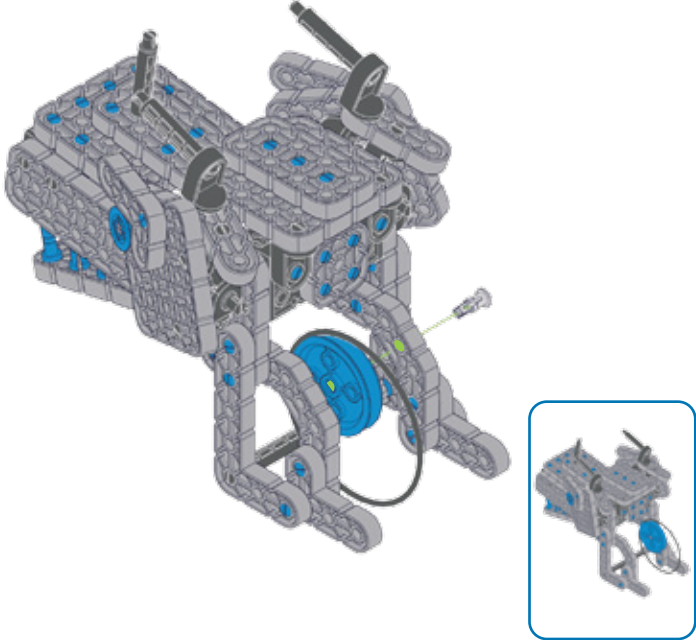

50

2x  228-2500-003

4x  228-2500-060

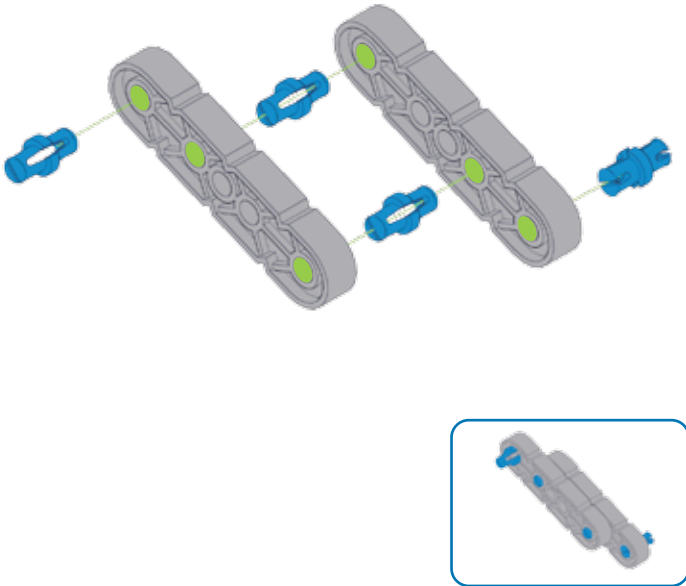

51

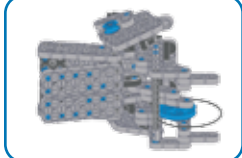
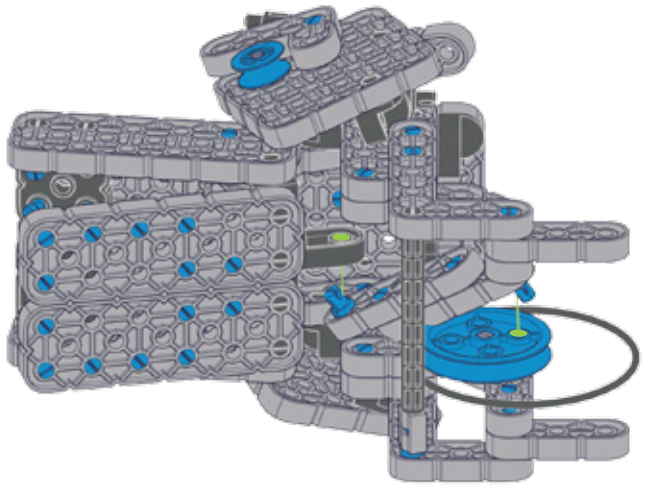
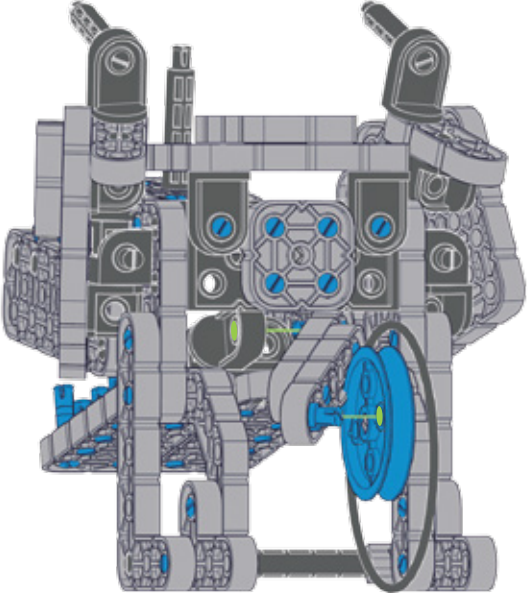

52

4x  
228-2500-060

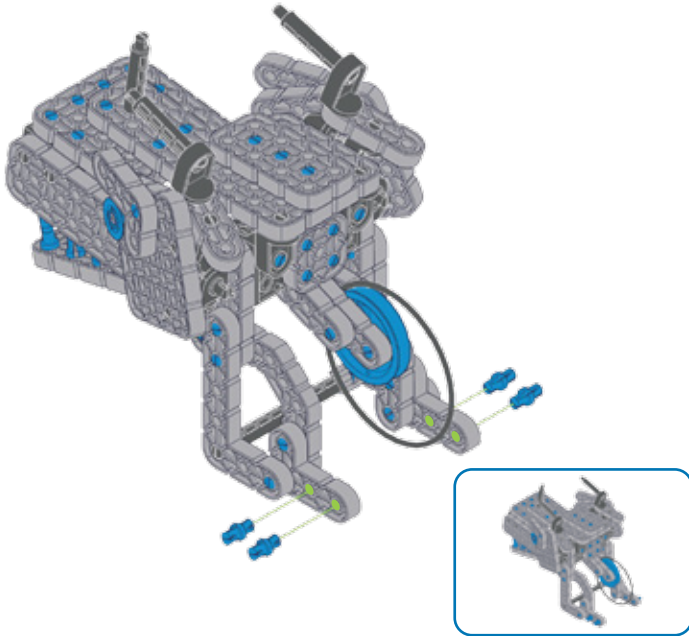

53

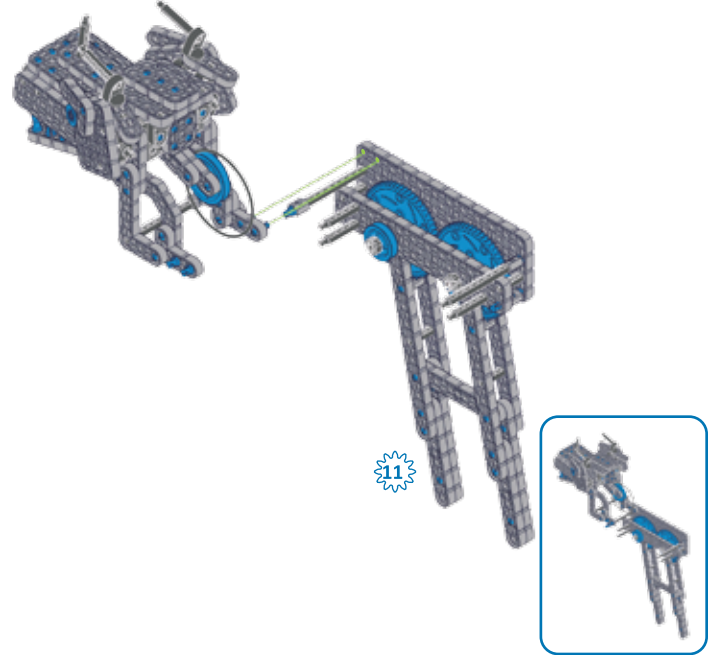
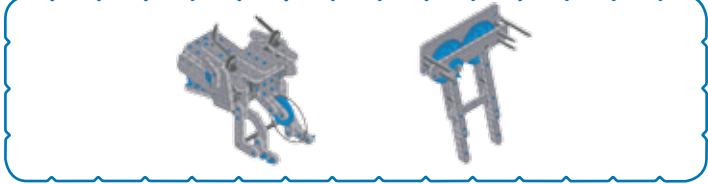

54

2x 228-2500-030  
 1x 228-2500-060  
 6x 228-2500-062

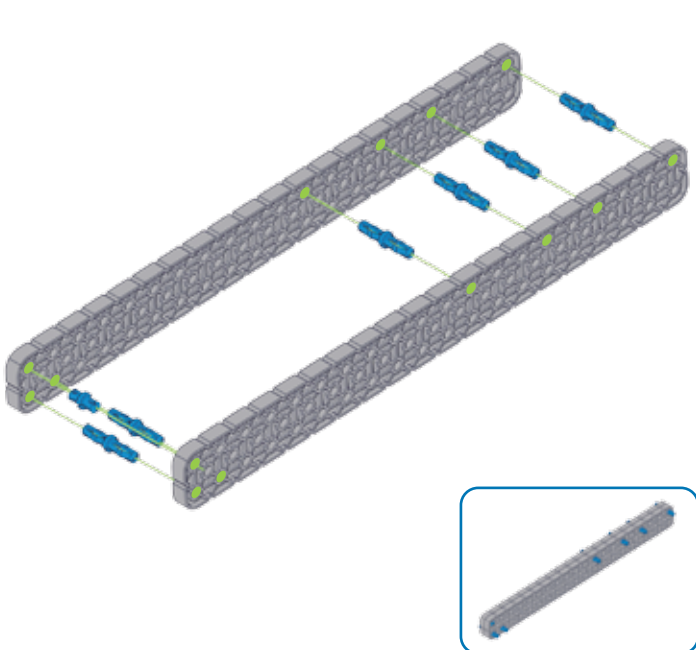

55

1x 228-2500-025  
 4x 228-2500-060  
 2x 228-2500-135

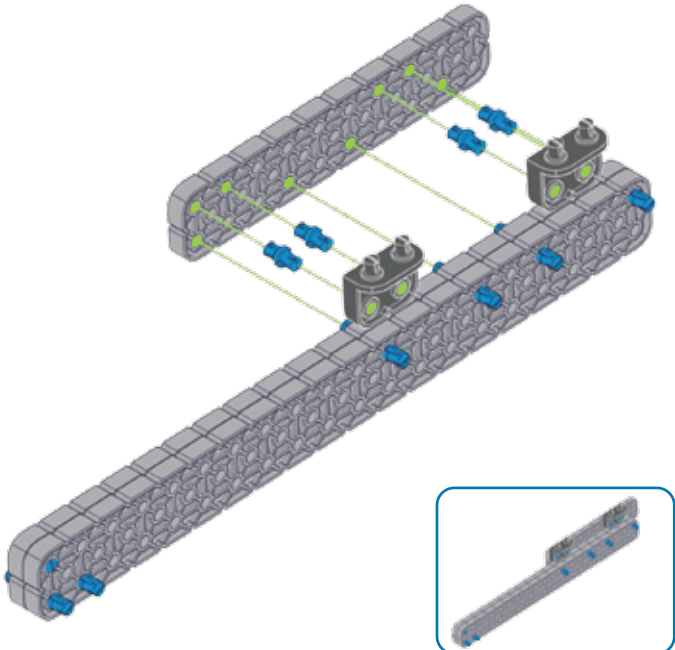

56

1x  
228-2500-025

2x  
228-2500-060

1x  
228-2500-135

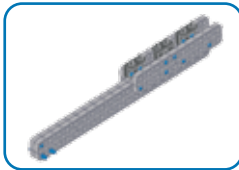
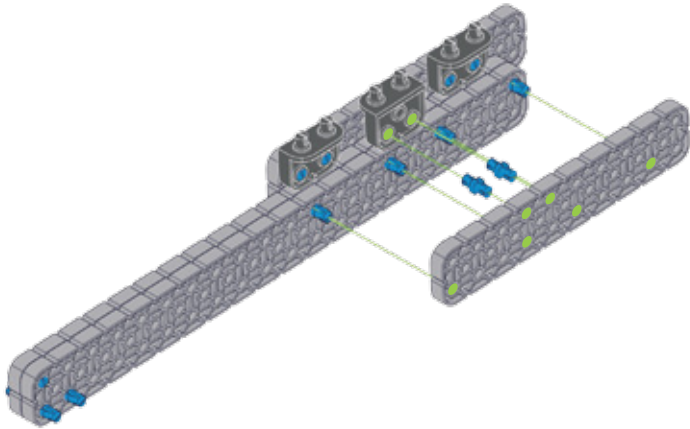

57

3x  
228-2500-131

6x  
228-2500-060

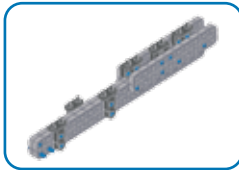
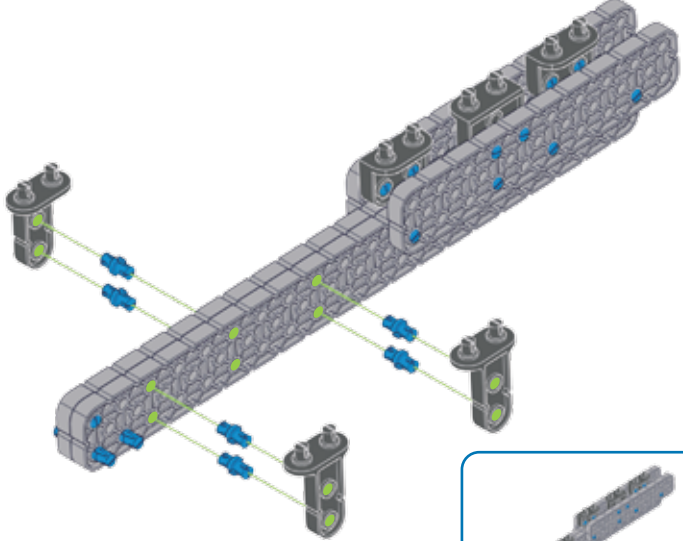

58

6x  
228-2500-172

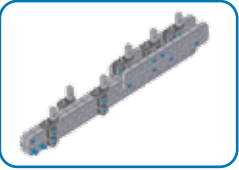
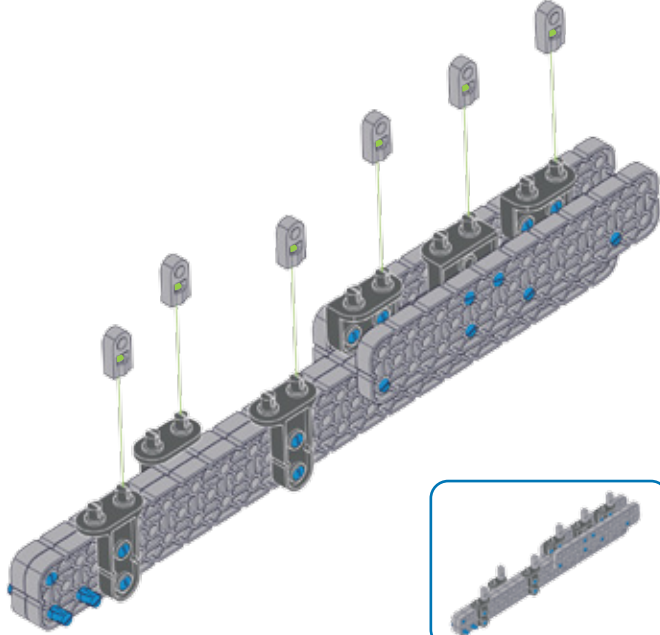

59

1x  
228-2500-148

1x  
228-2500-149

1x  
228-2500-060

2x  
228-2500-062

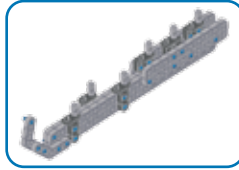
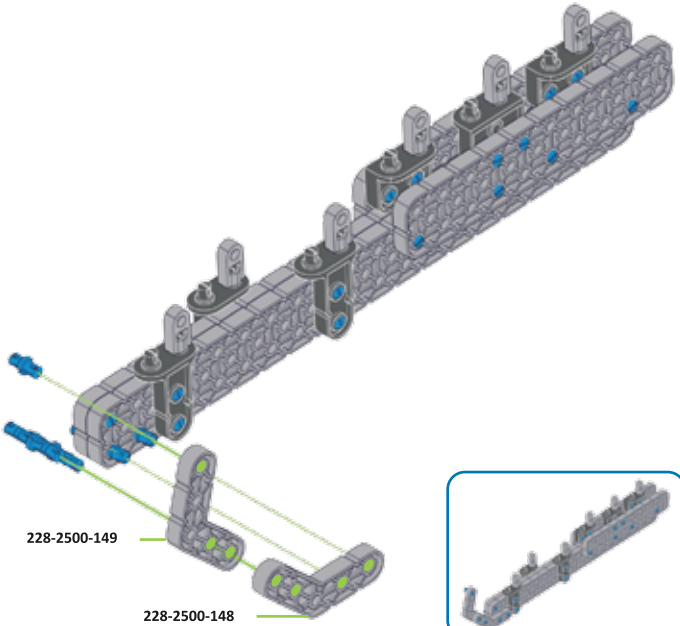

60

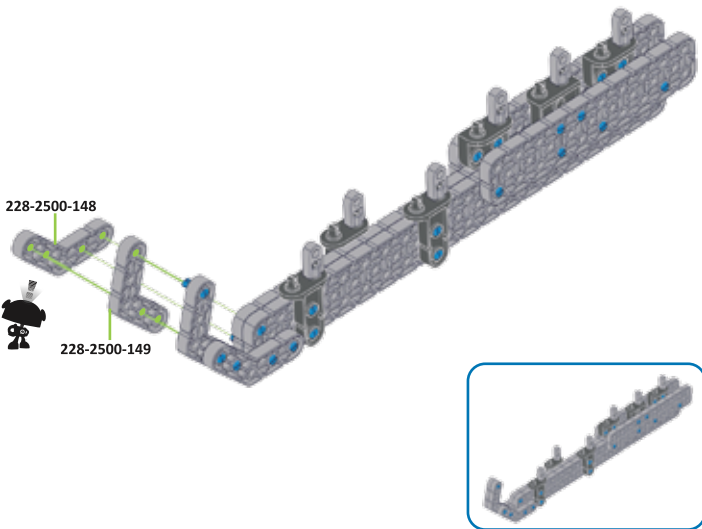
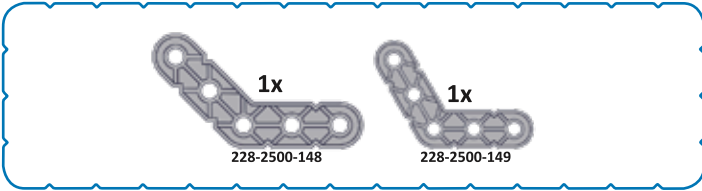

61

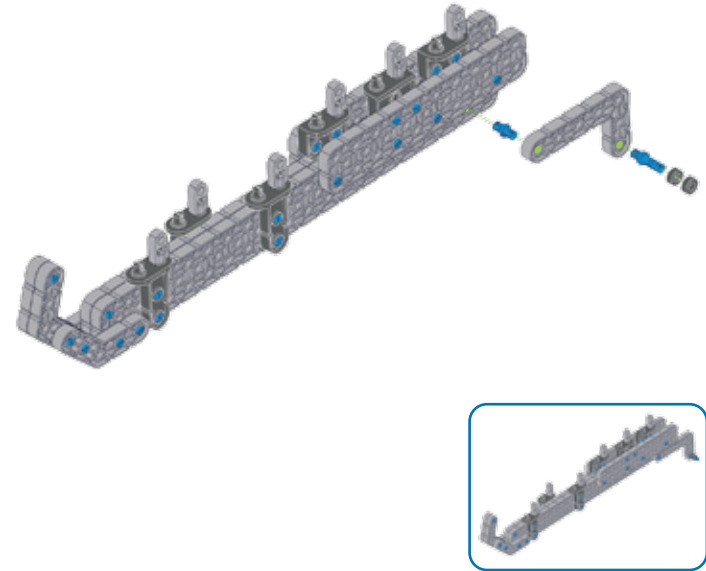
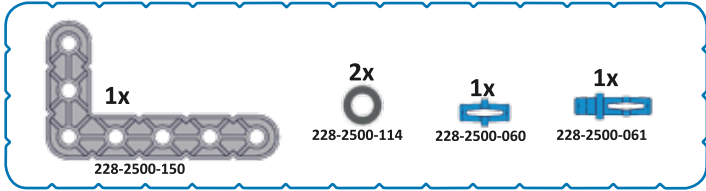

62

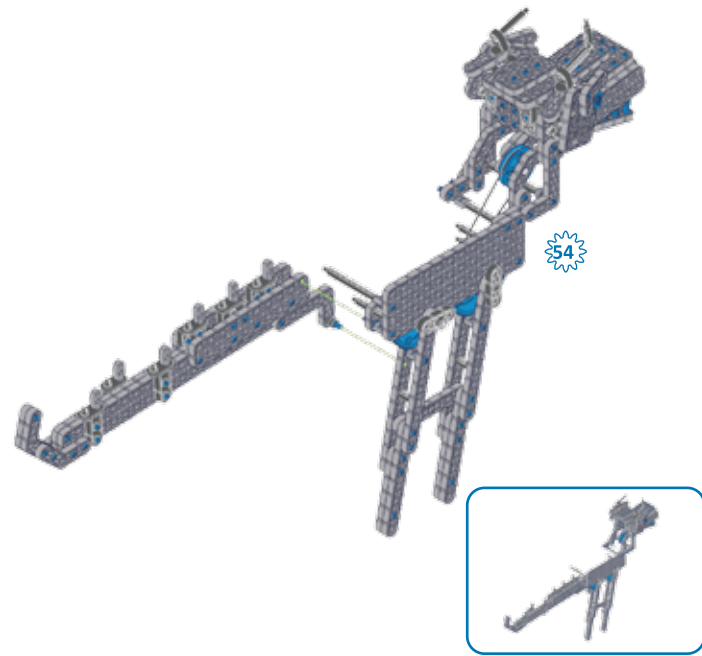
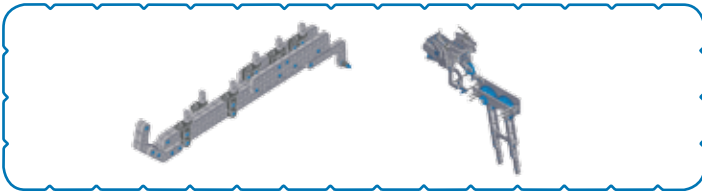

63

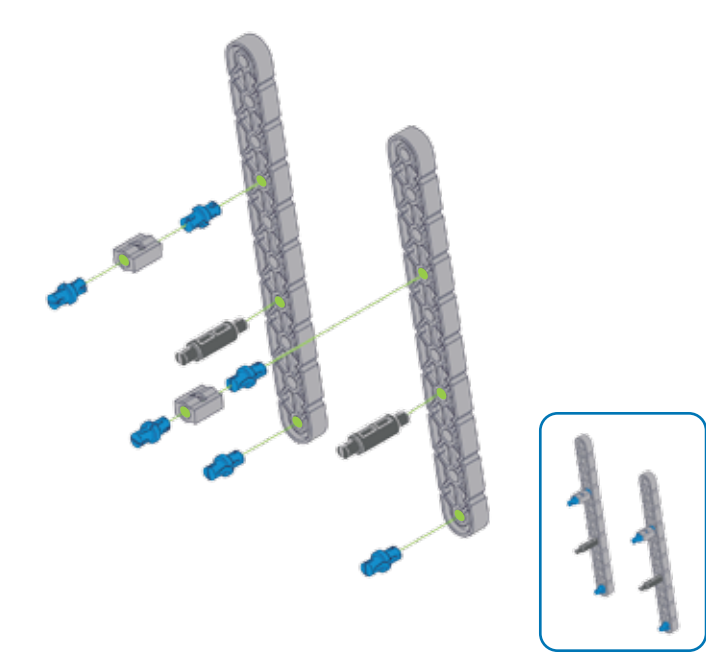
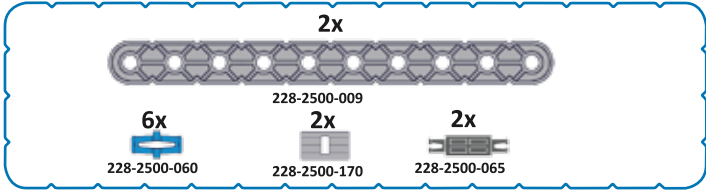

64

2x 228-2500-007

2x 228-2500-062

4x 228-2500-061

2x 228-2500-060

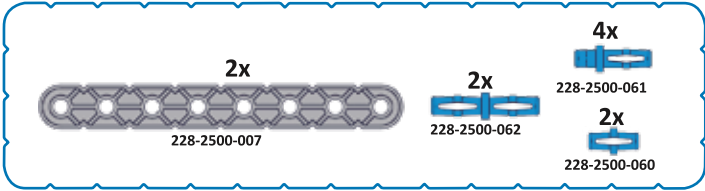
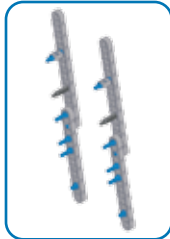
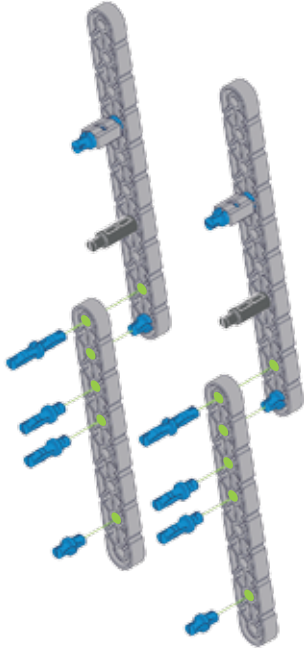
65

3x 228-2500-005

66

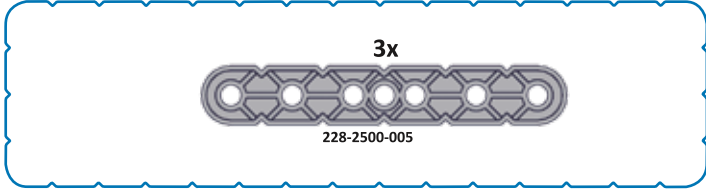
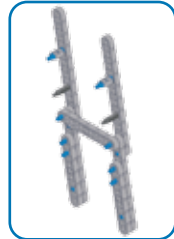
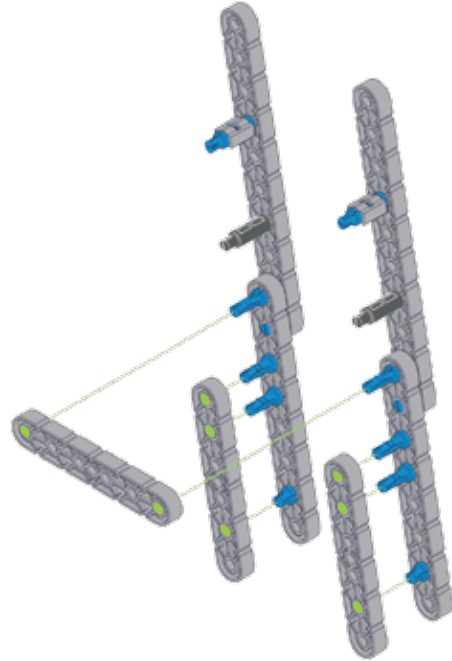
1x 228-2500-082

1x 228-2500-120

2x 228-2500-141

2x 228-2500-112

1x 228-2500-143

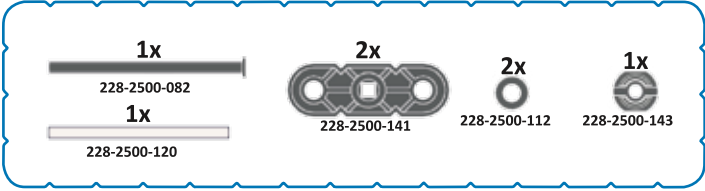
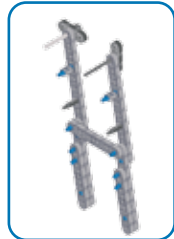
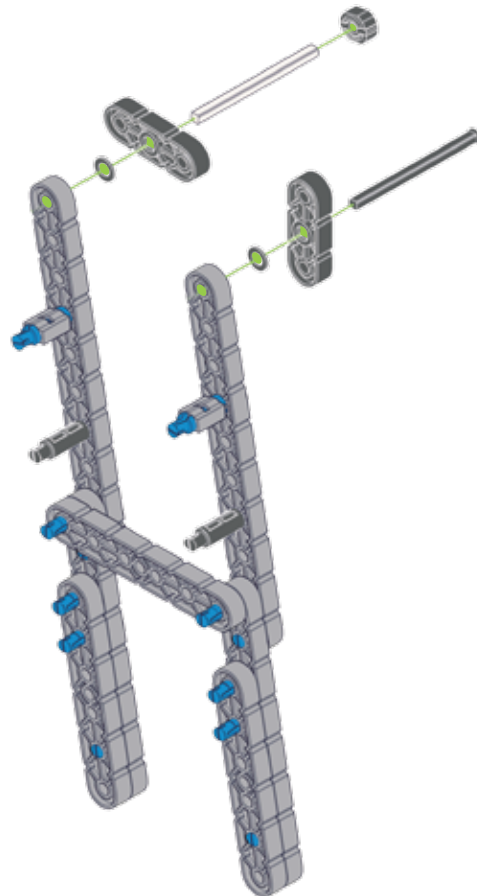
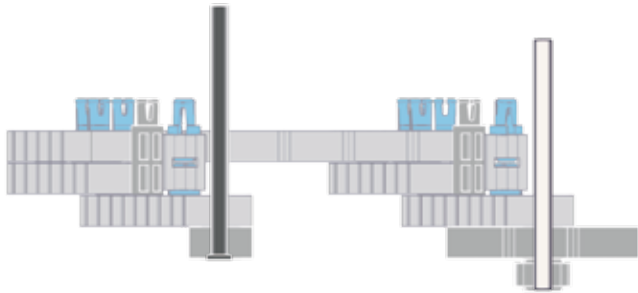

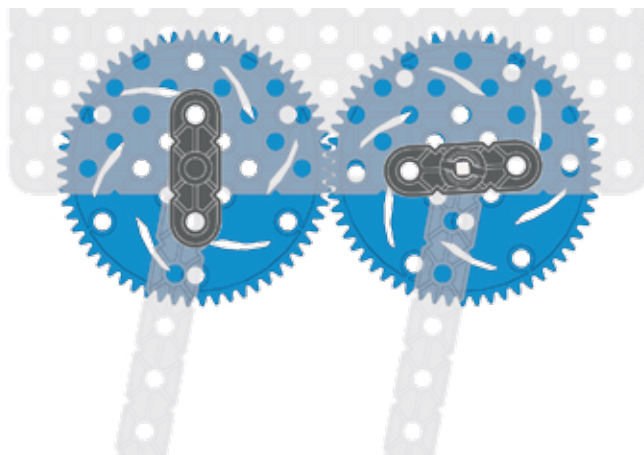
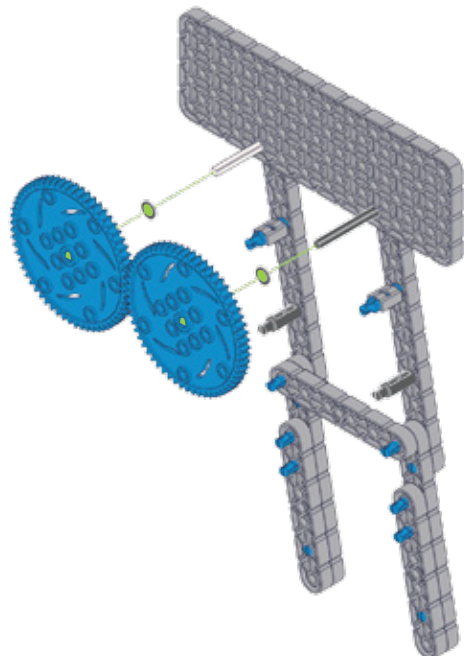
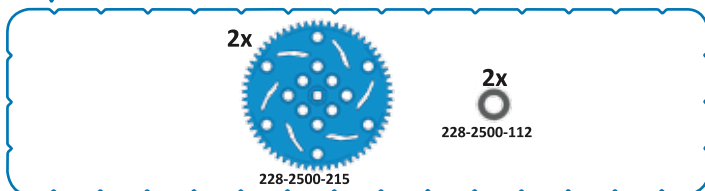
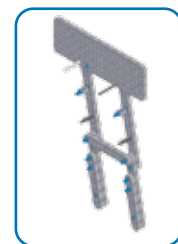
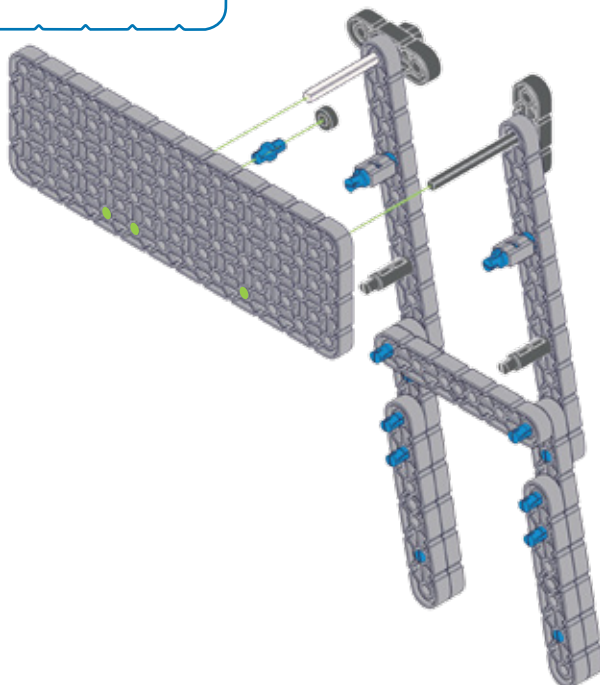
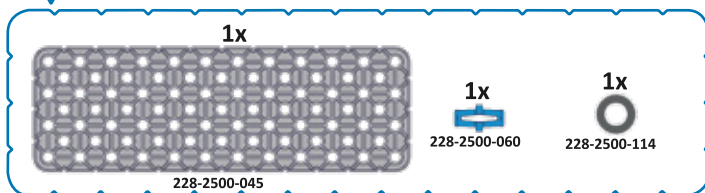
Убедитесь, что отверстия деталей 228-2500-141 и 228-2500-215 находятся в положении, как на рисунке.

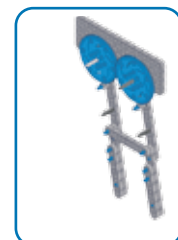

69

2x 228-2500-011

2x 228-2500-112

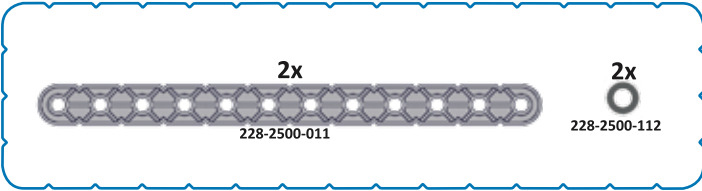
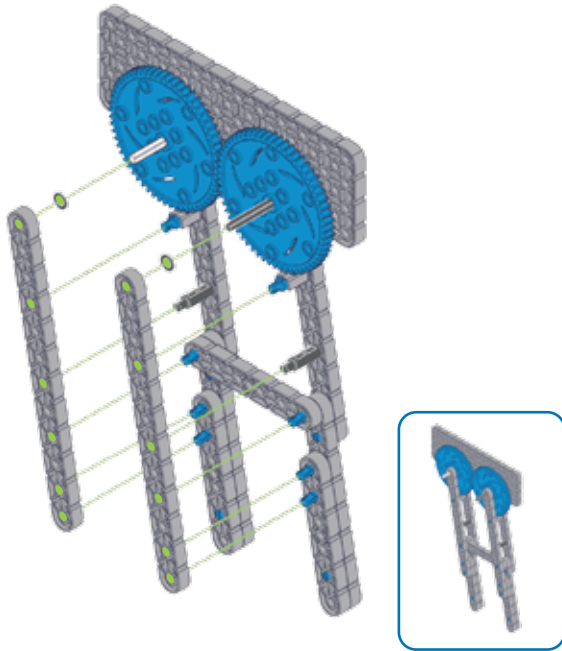
70

1x 228-2500-026

1x 228-2500-061

3x 228-2500-060

2x 228-2500-065

2x 228-2500-170

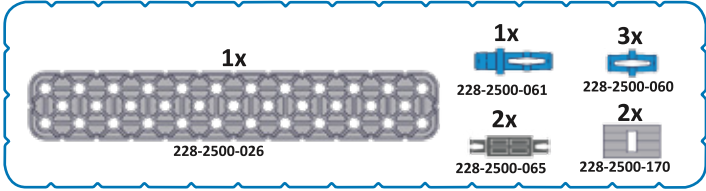
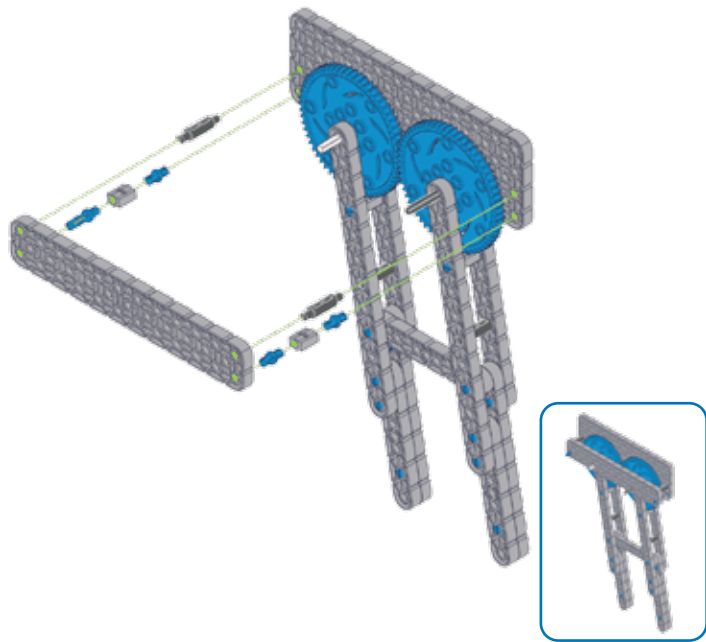
71

2x 228-2500-143



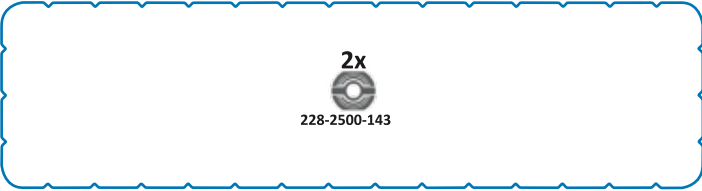
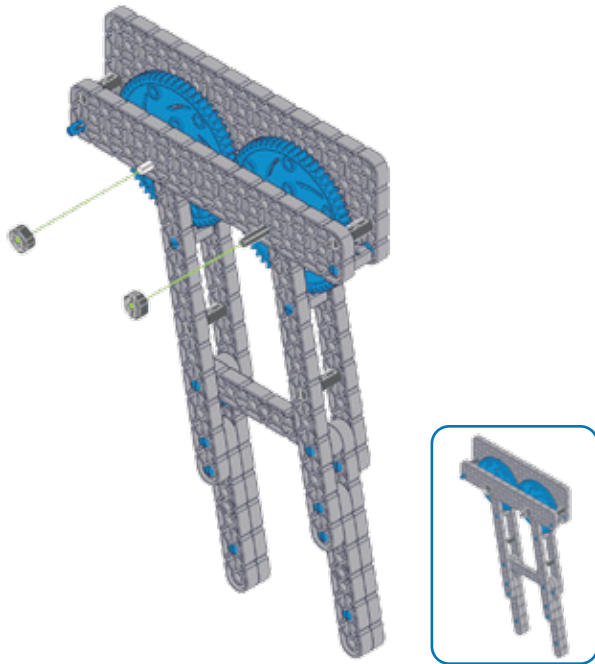

72

1x 228-2500-078

1x 228-2500-112

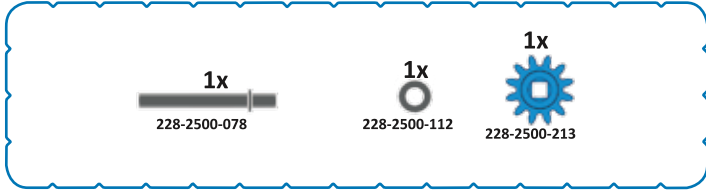
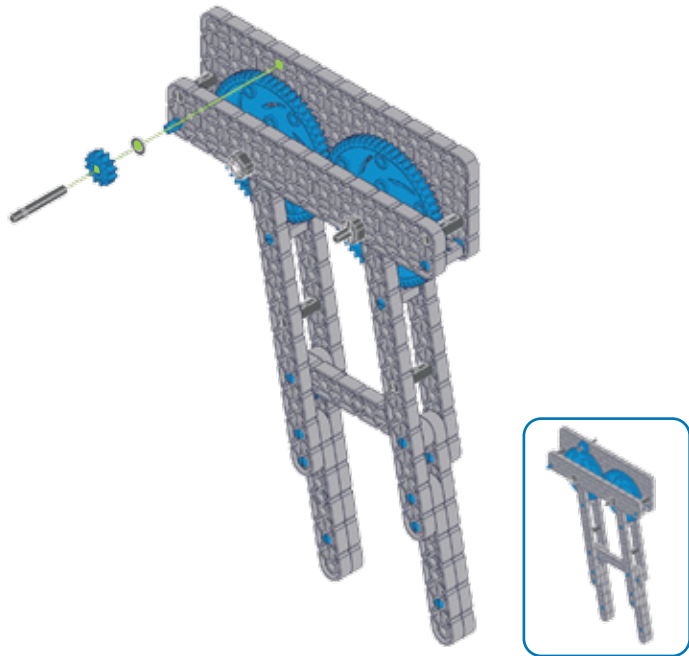
1x 228-2500-213

73

4x  
228-2500-064

1x  
228-2560

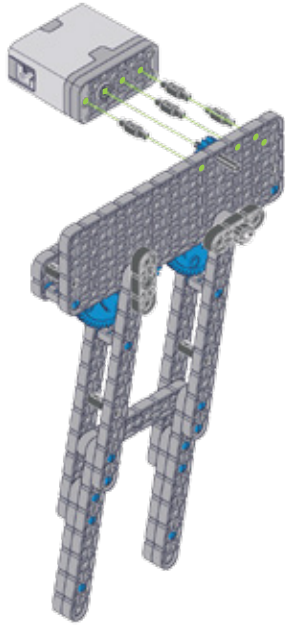

74

1x  
228-2500-124

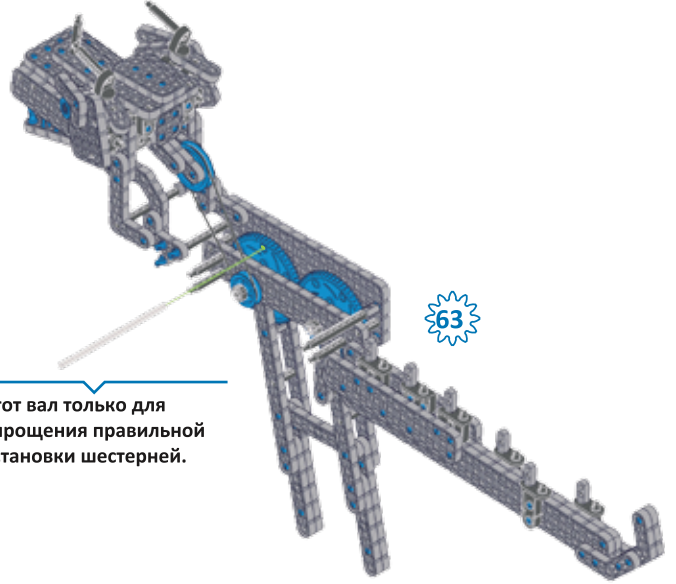

63

Этот вал только для упрощения правильной установки шестерней.

75

1x  
228-2500-122

2x  
228-2500-143

2x  
228-2500-112

2x  
228-2500-213

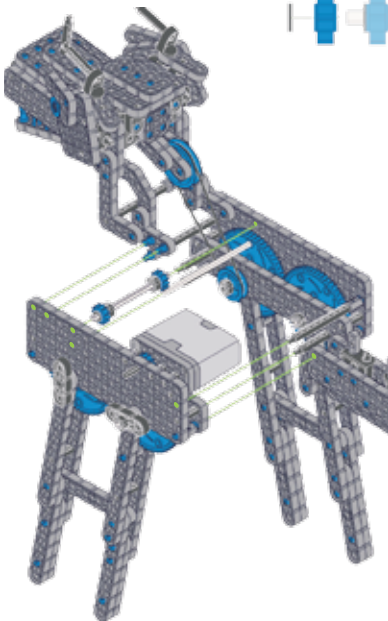

Убедитесь, что шестерни соответствуют шагам 6 и 69.



76

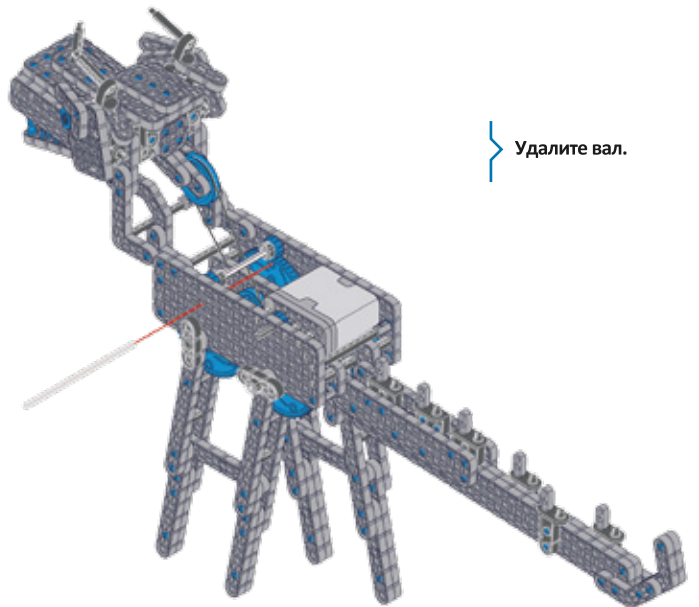

Удалите вал.



77

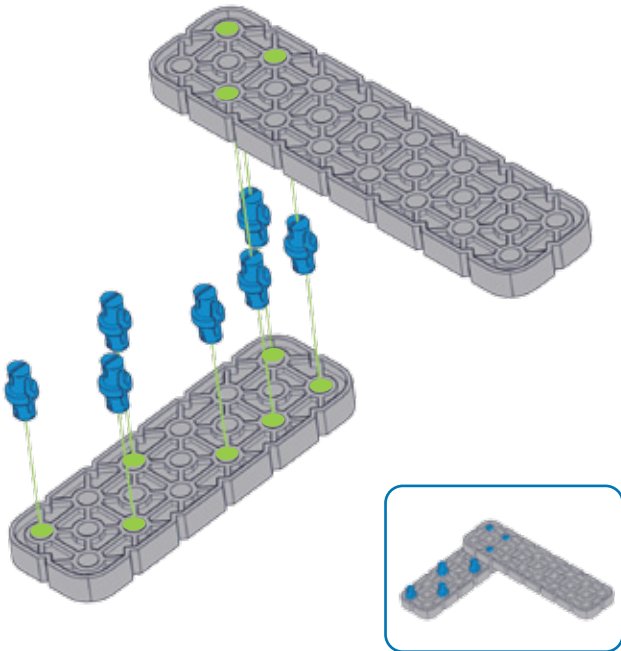
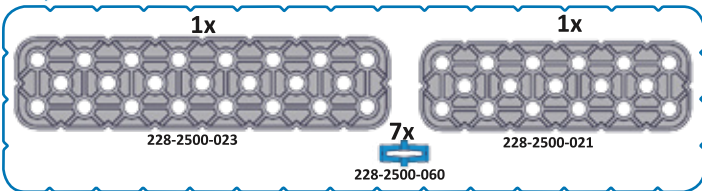

78

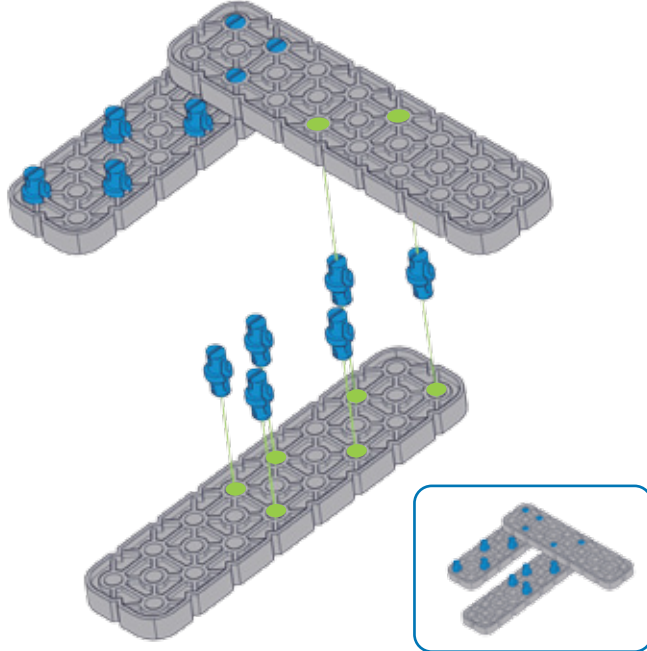
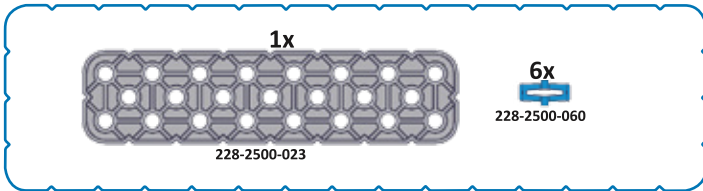

79

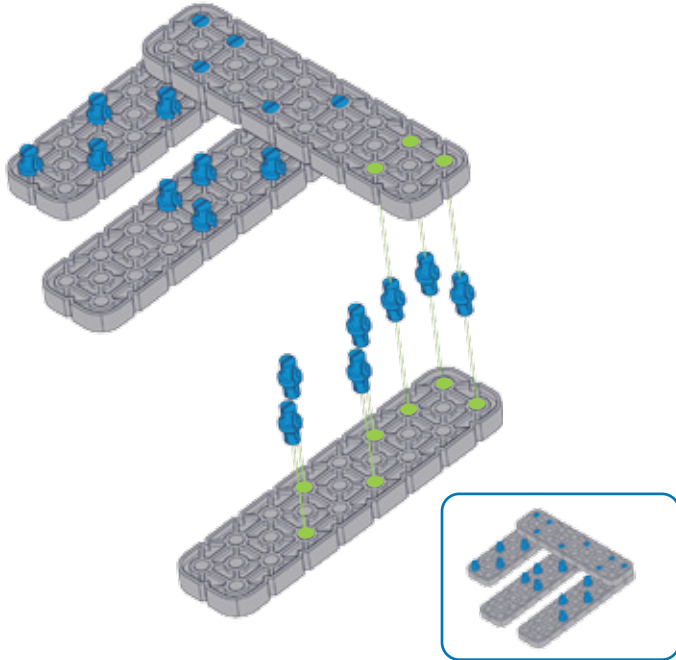
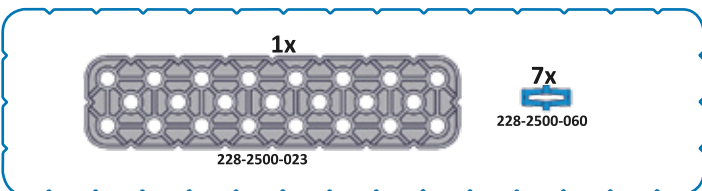

80

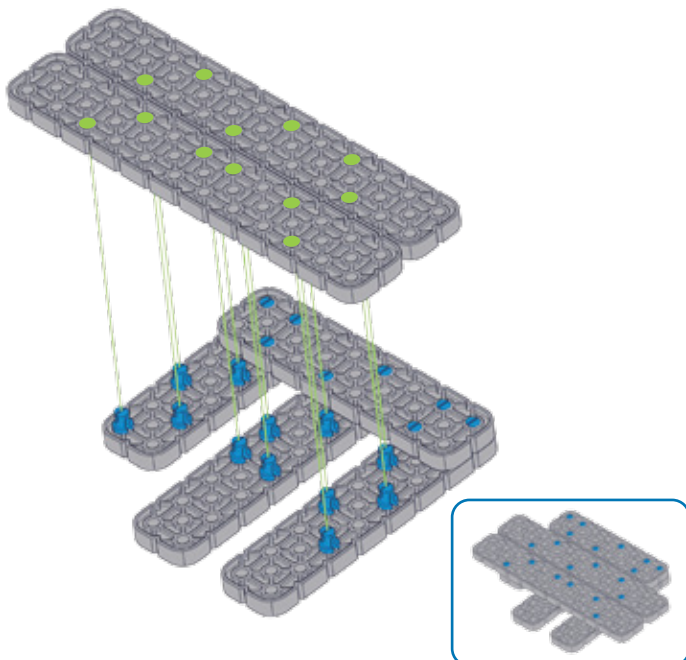
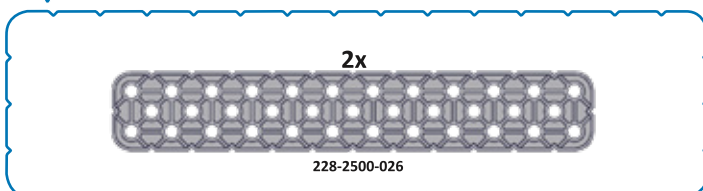

81

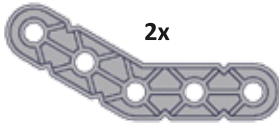
2x  228-2500-147

6x  228-2500-060

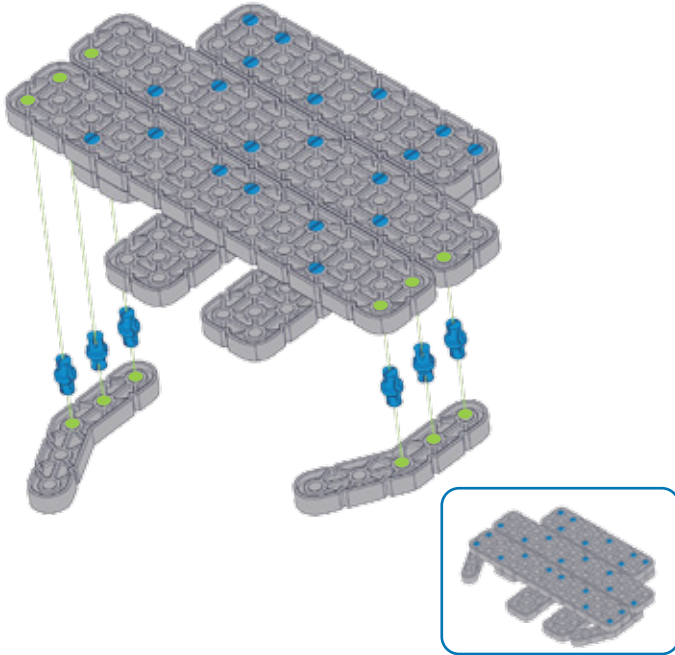

82

2x  228-2500-127



1x  228-2500-124

2x  228-2500-143

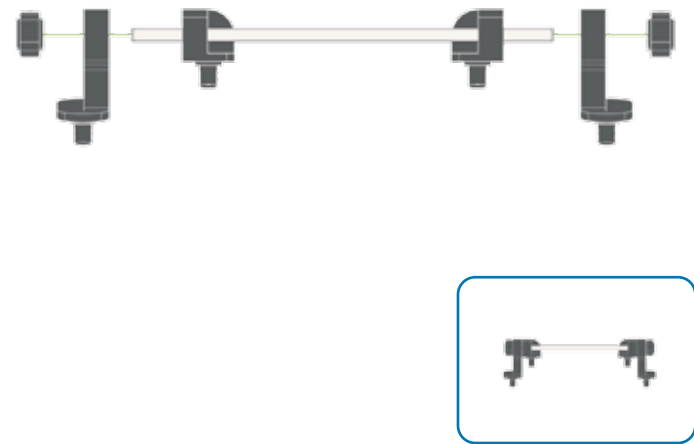
2x  228-2500-132



83

  1x  228-2500-133

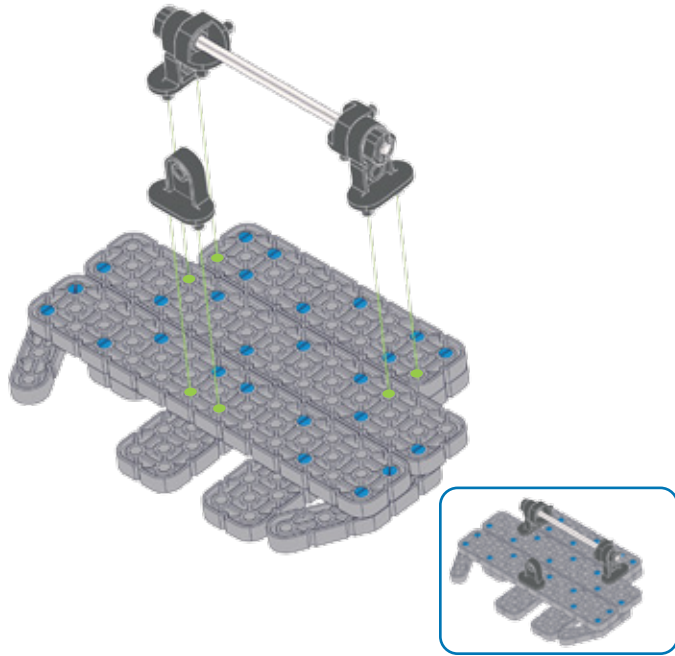

84

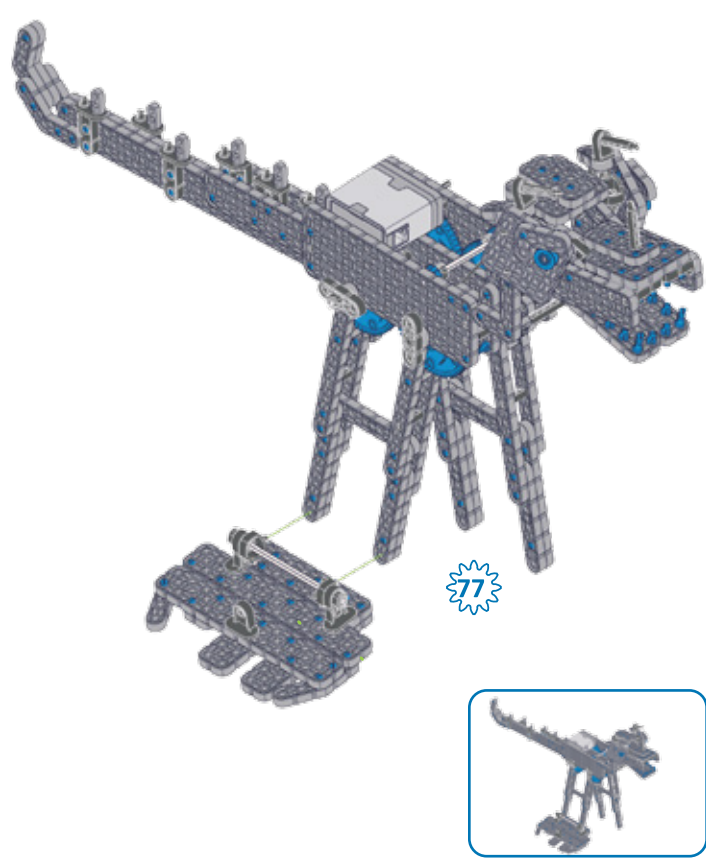

85

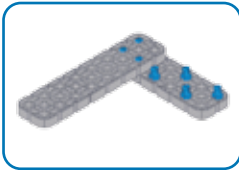
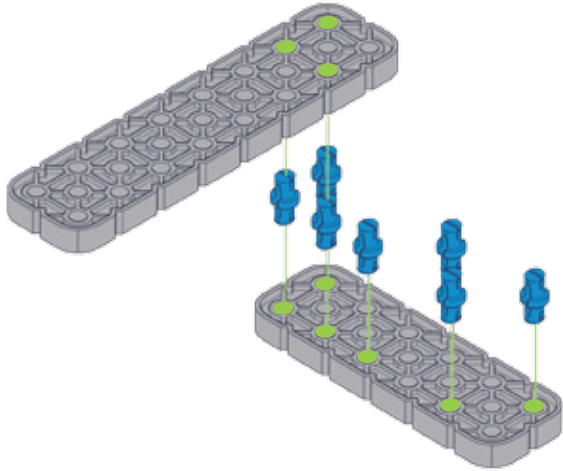
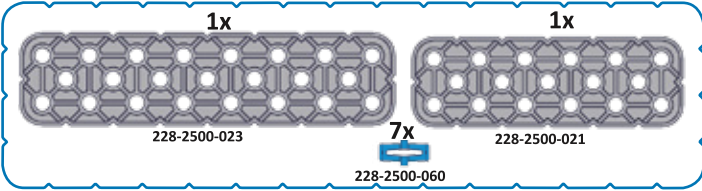

86

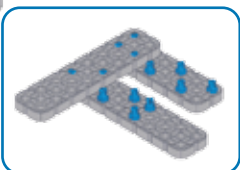
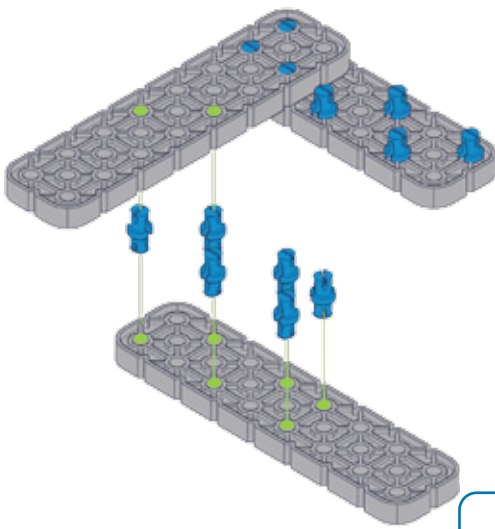
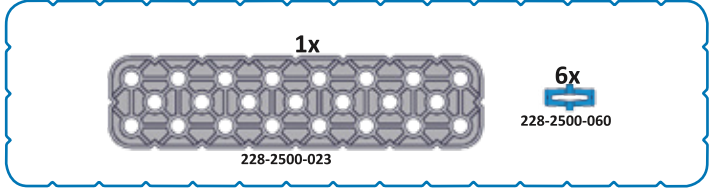

87

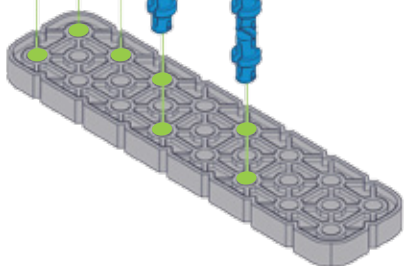
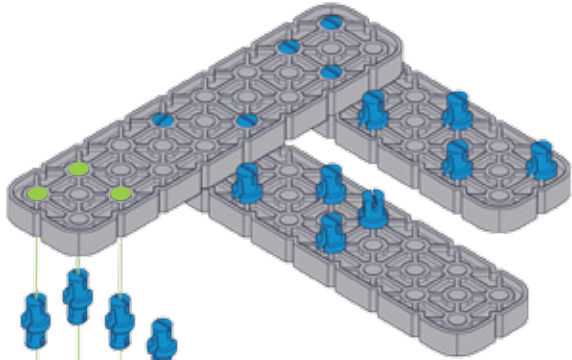
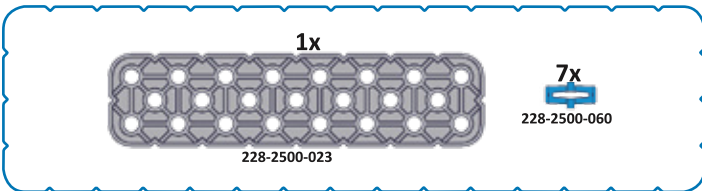

88

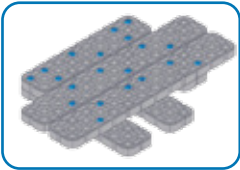
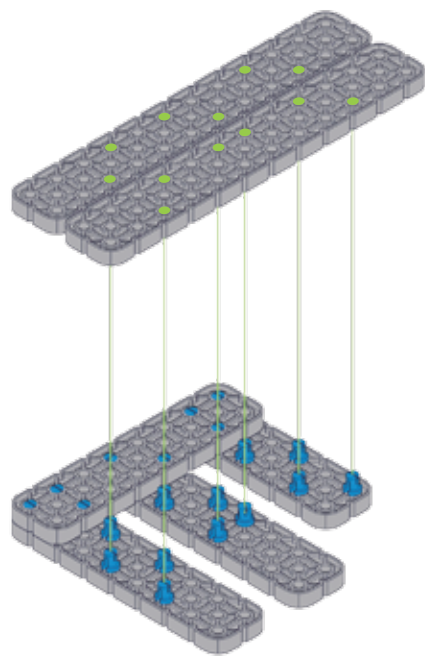
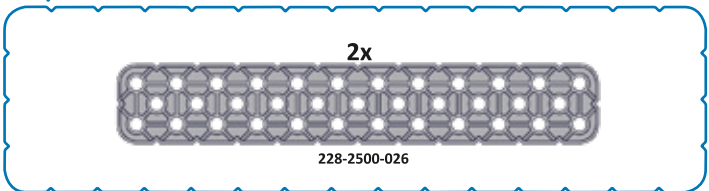

89

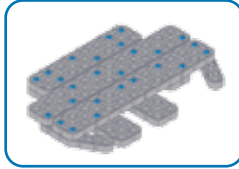
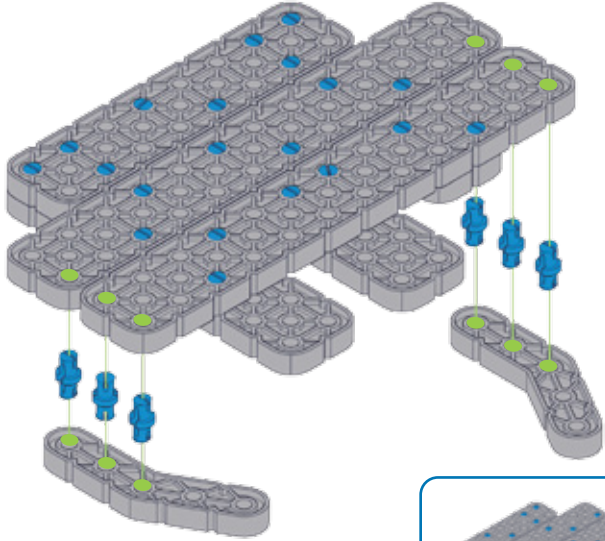
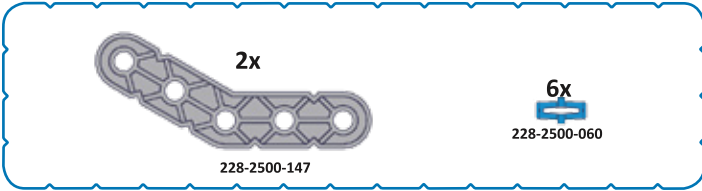

90

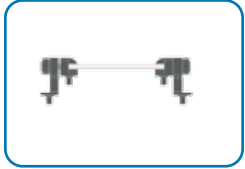
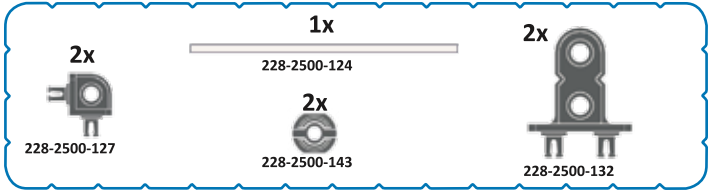

91

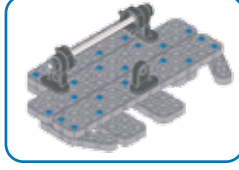
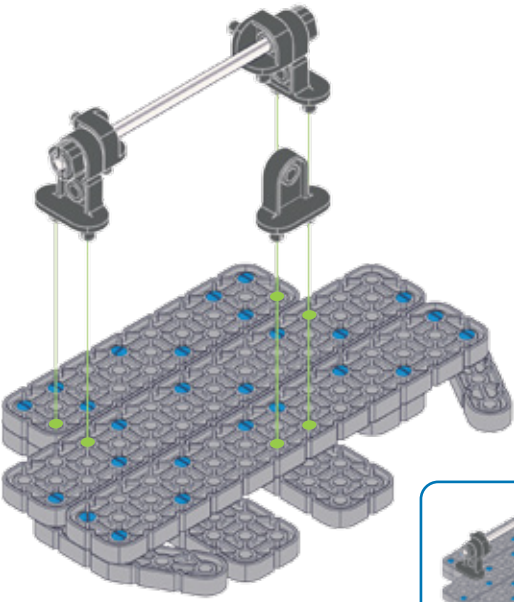
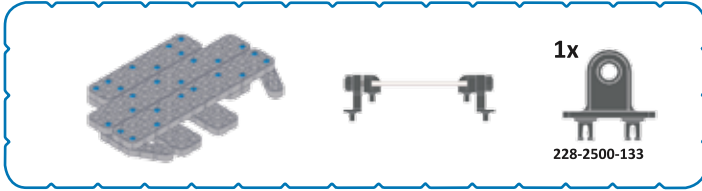

92

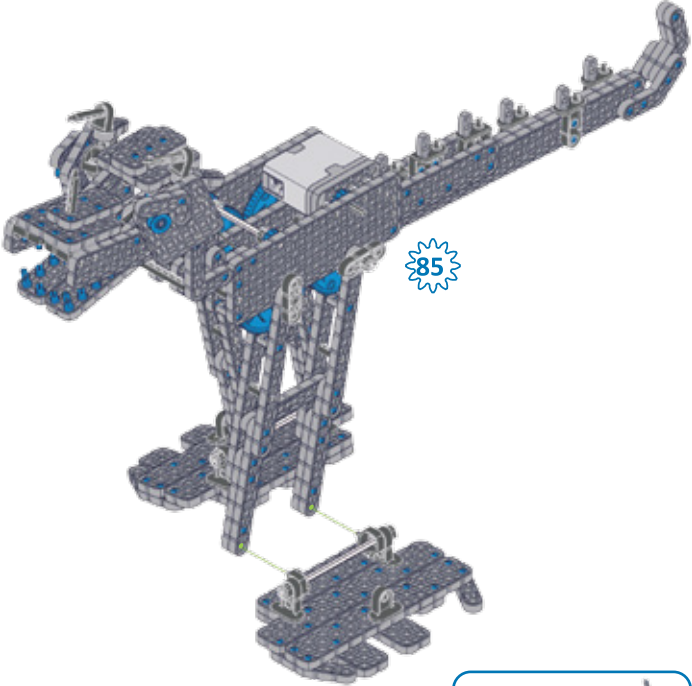

85



93

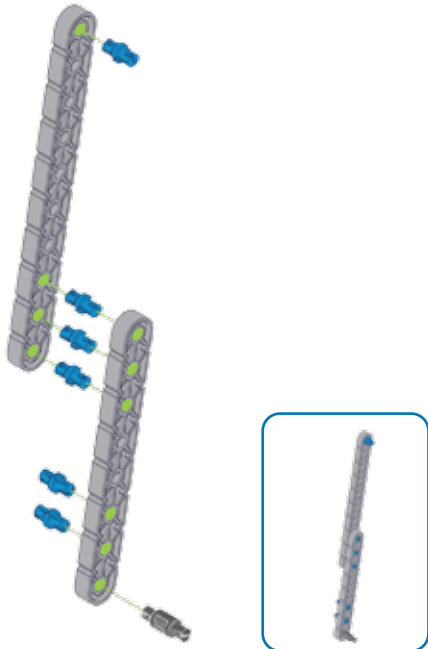
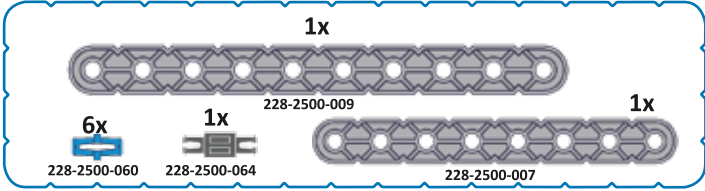

94

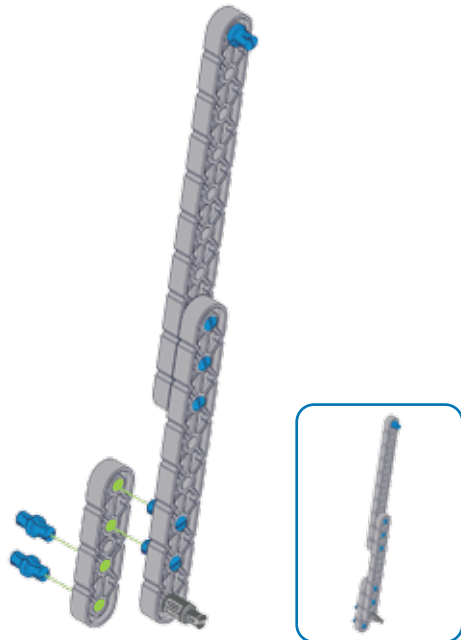
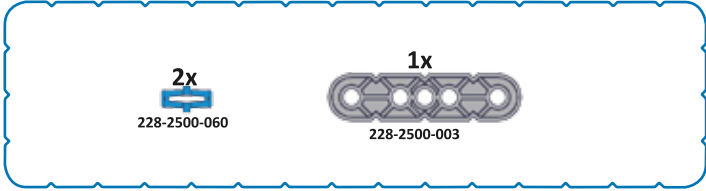

95

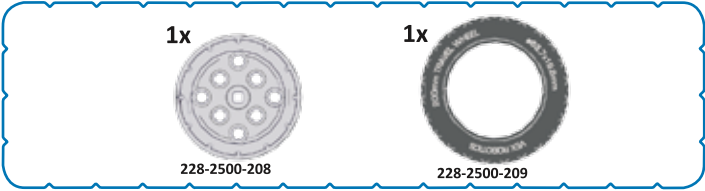

96

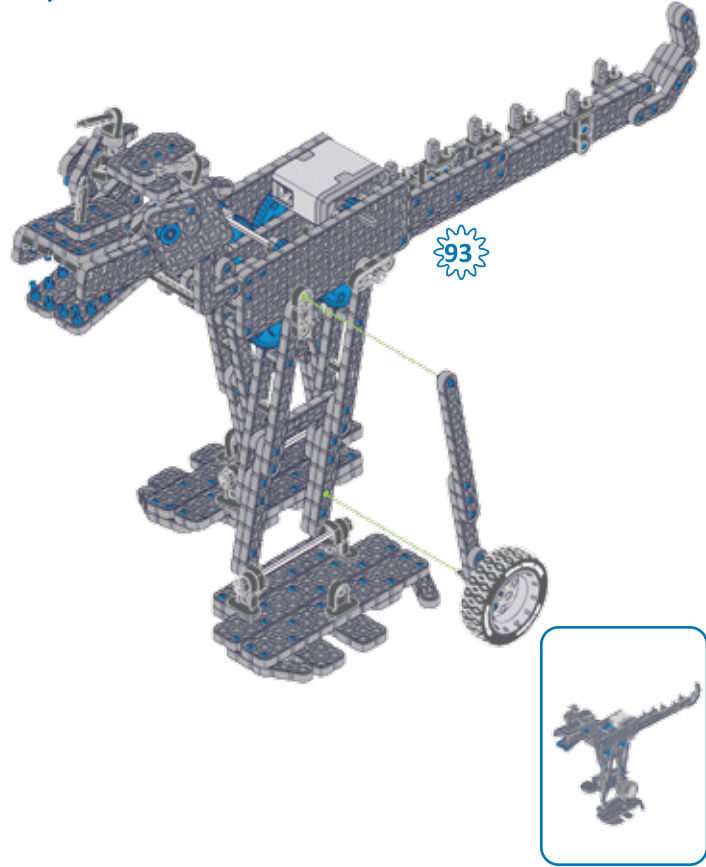

97

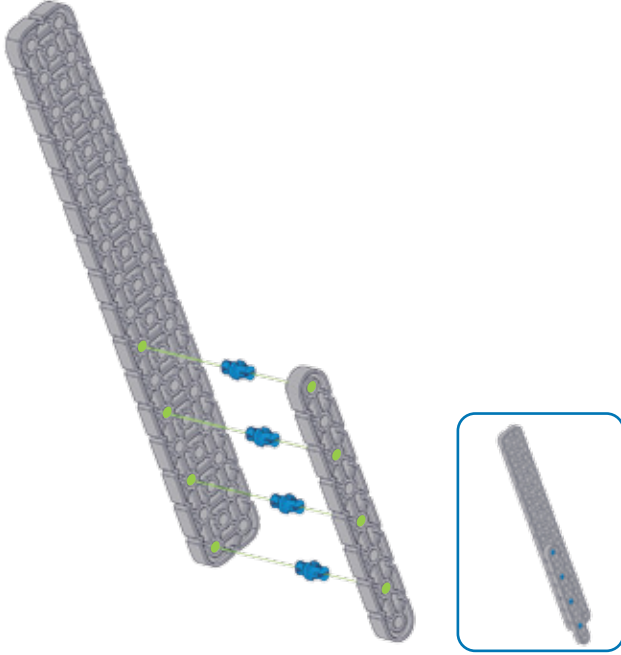
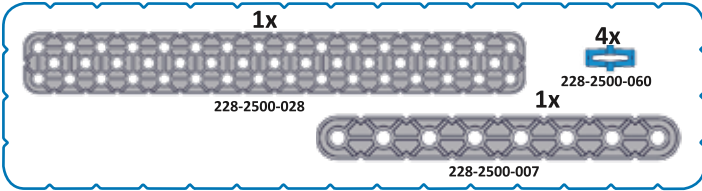

98

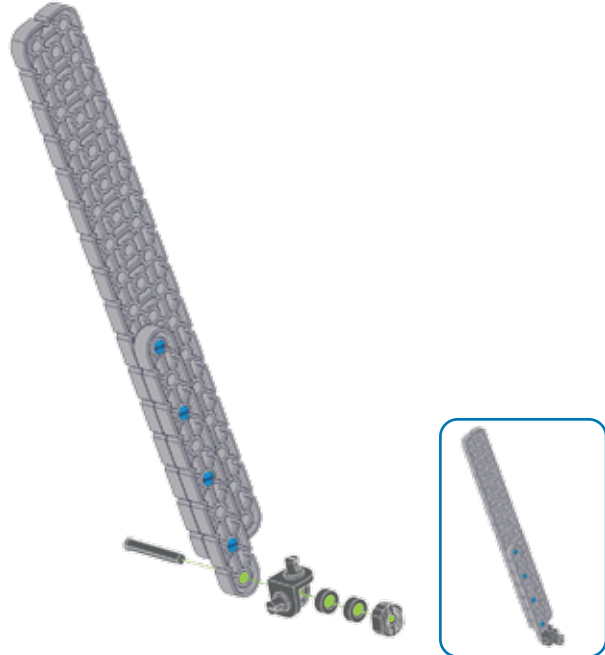
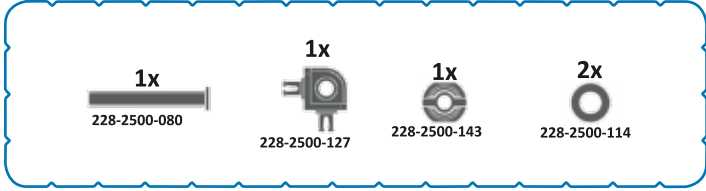

99

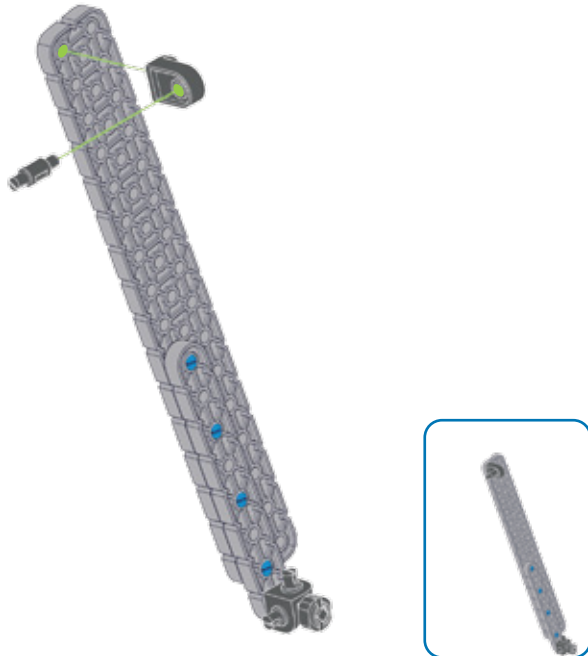
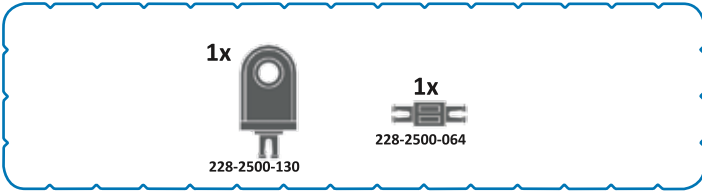

100

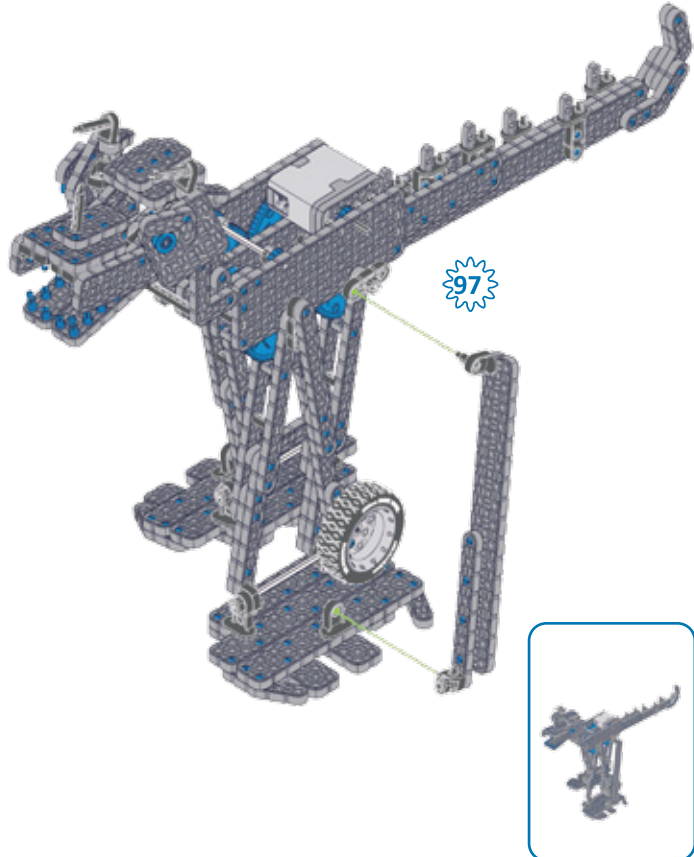

101

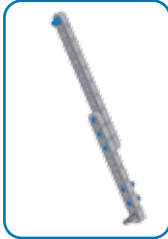
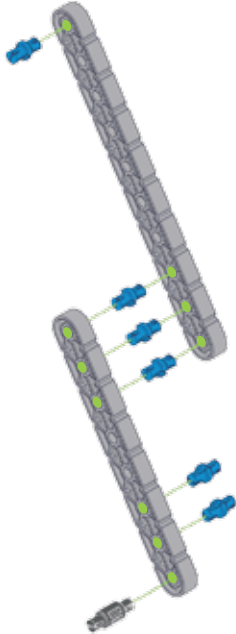
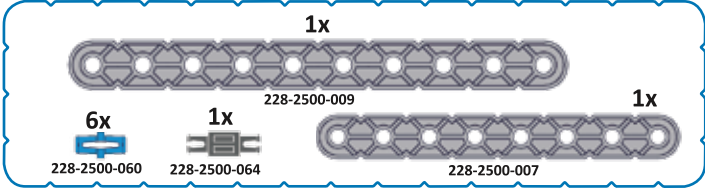

102

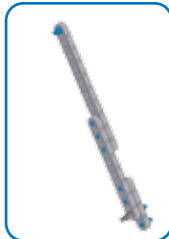
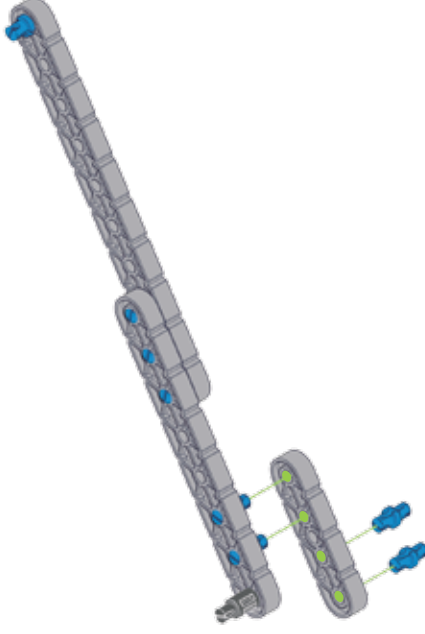
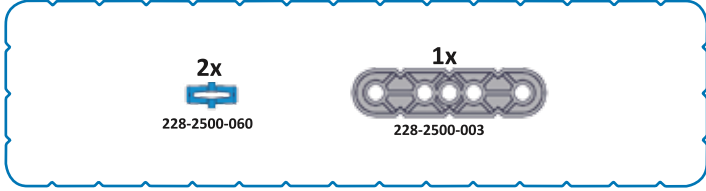

103

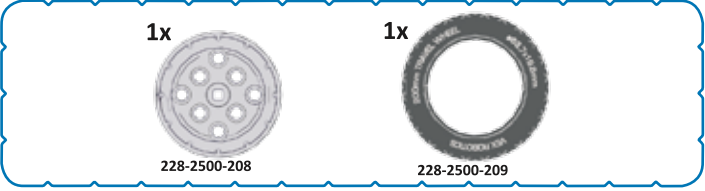

104

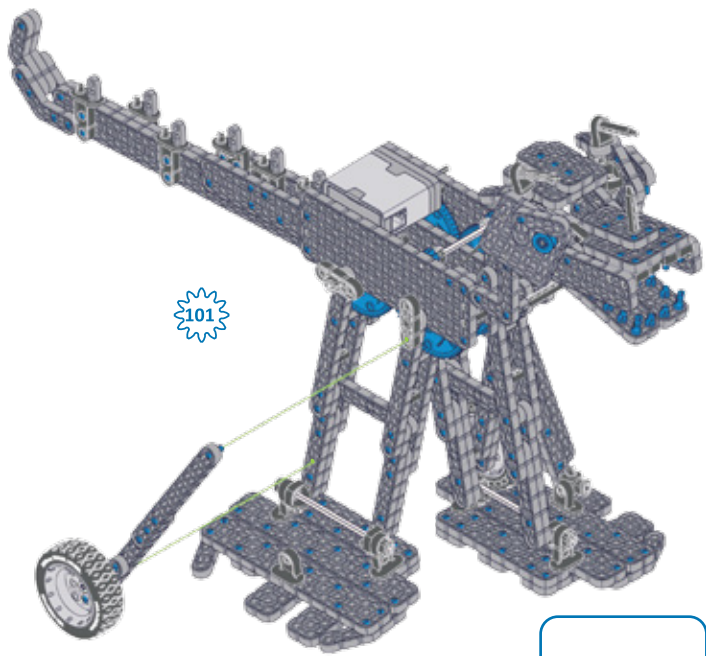

105

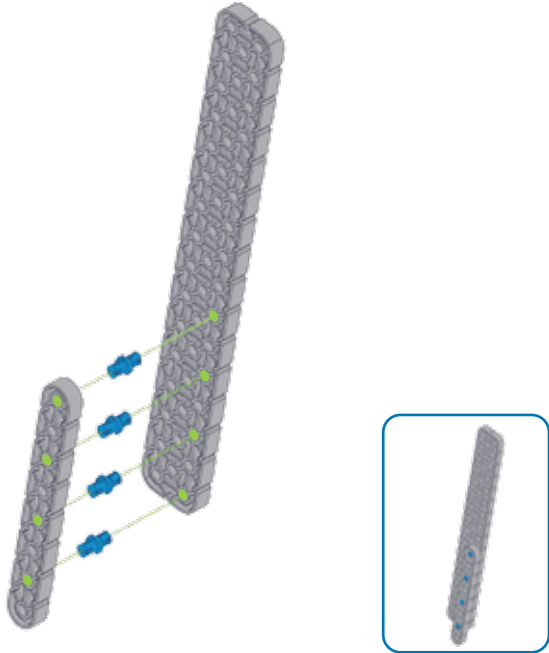
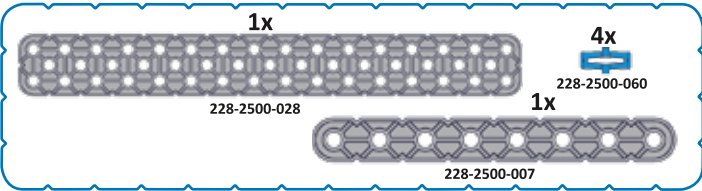

106

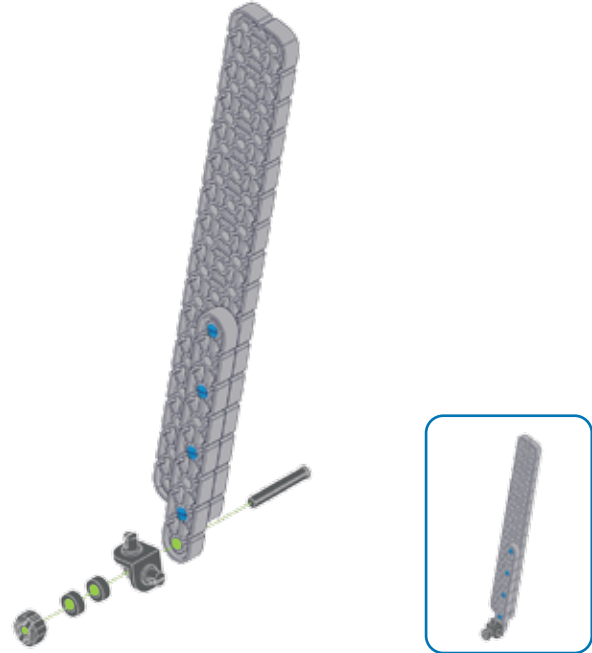
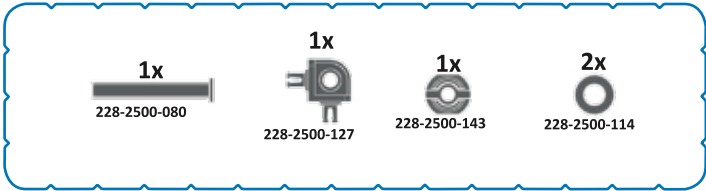

107

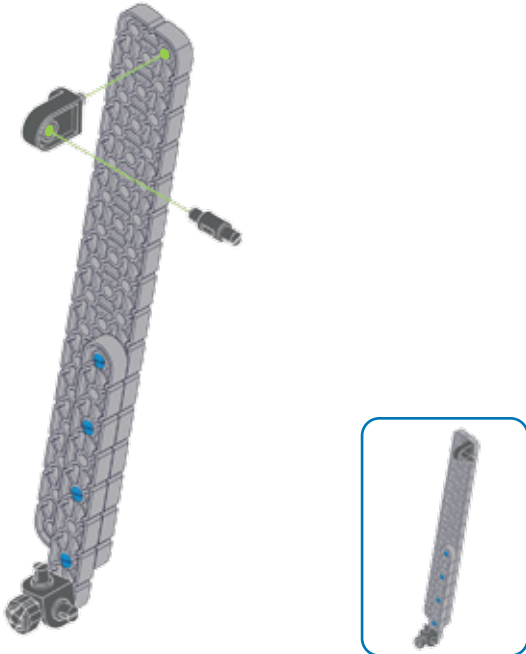
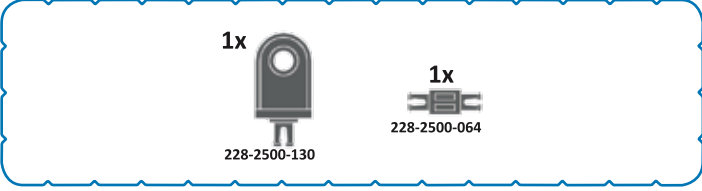

108

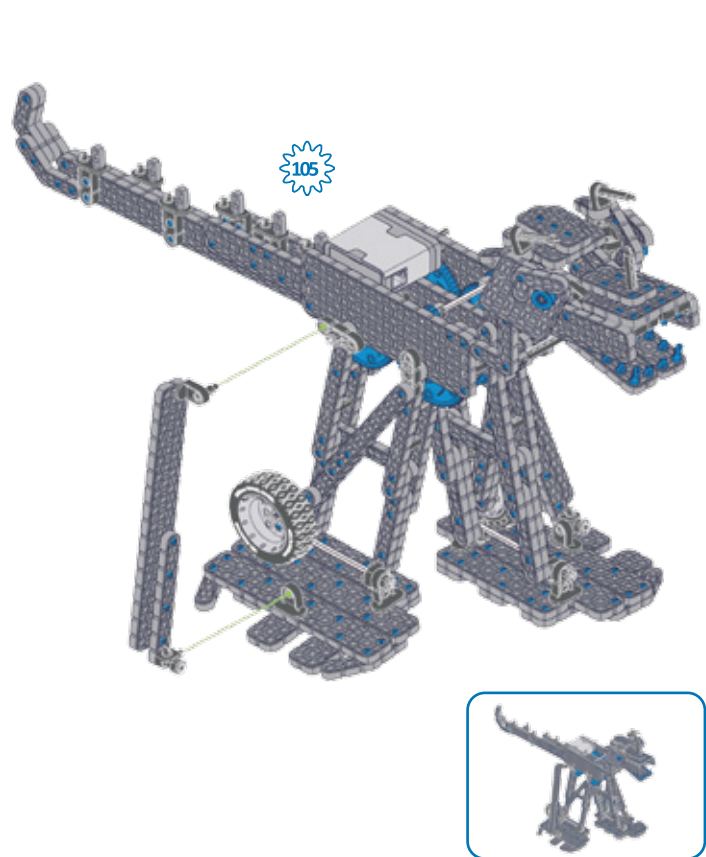



109

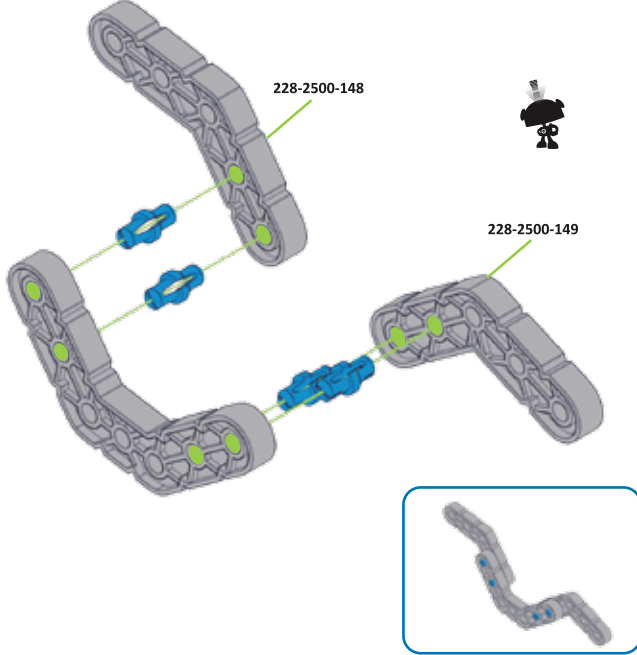
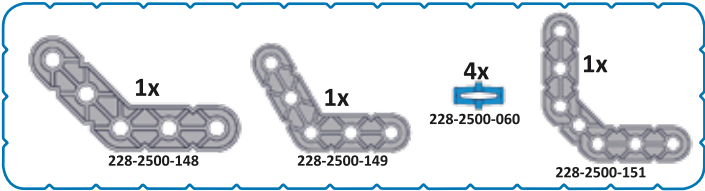

110

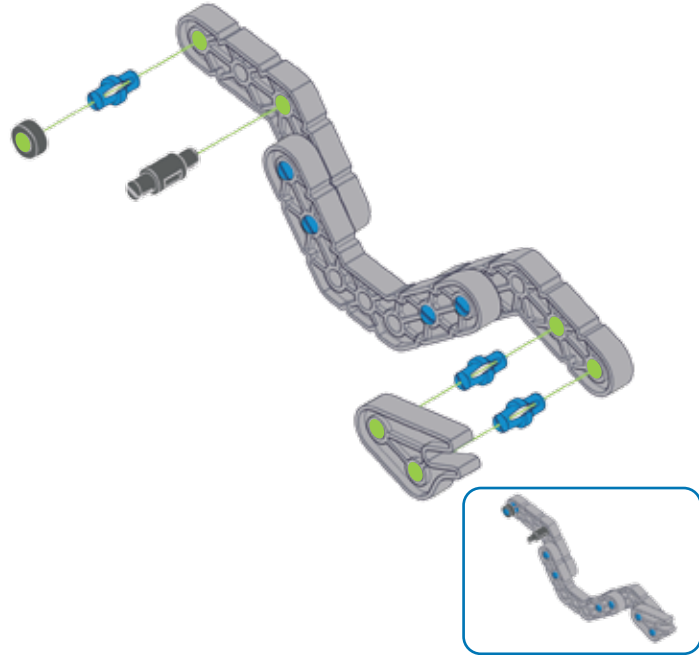
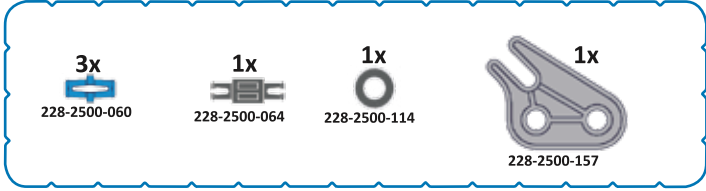

111

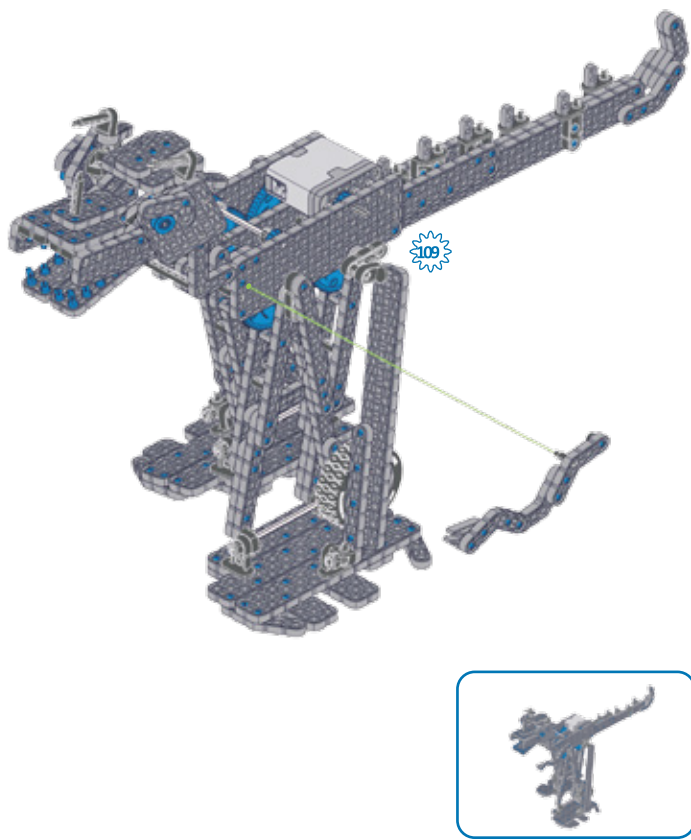

112

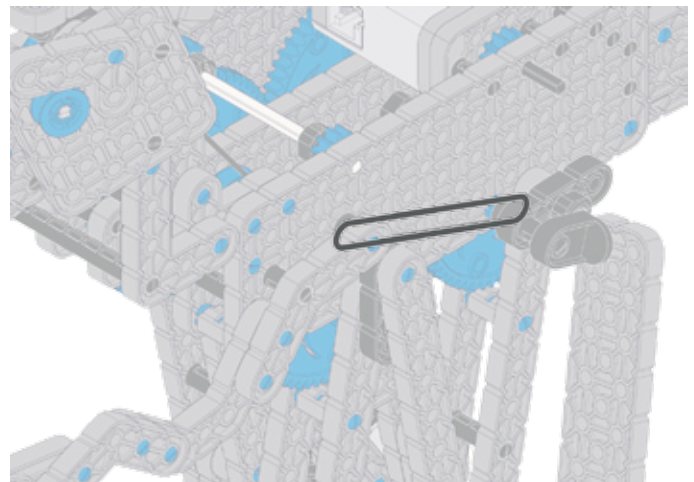
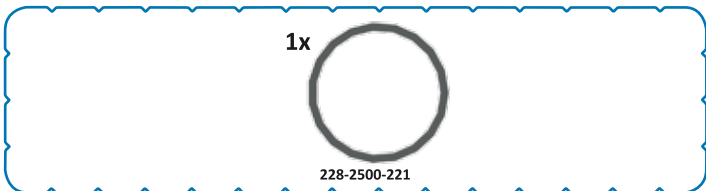

113

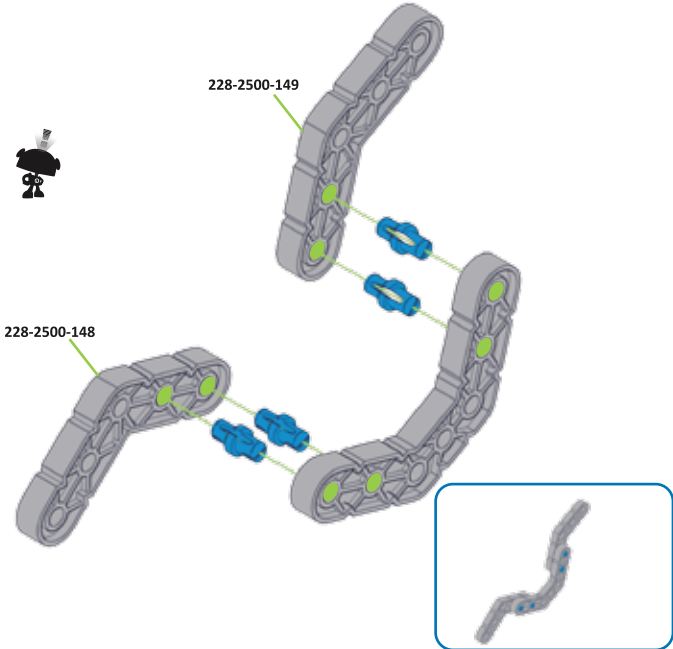
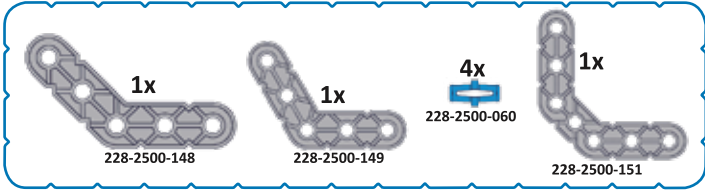

114

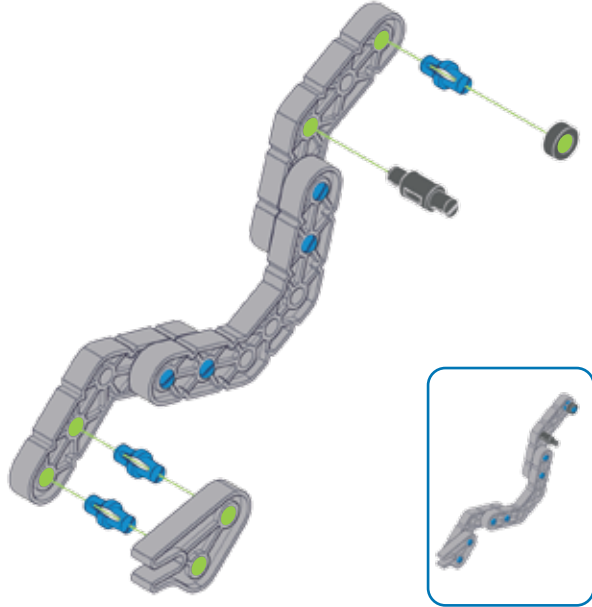
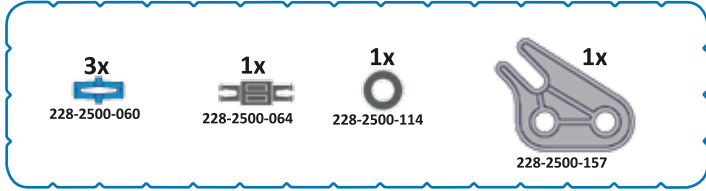

115

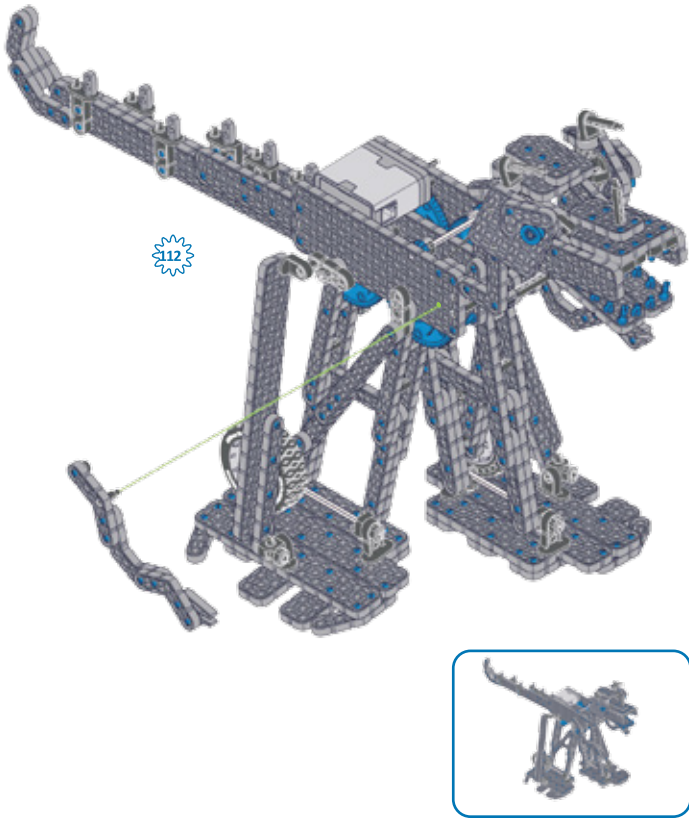

116

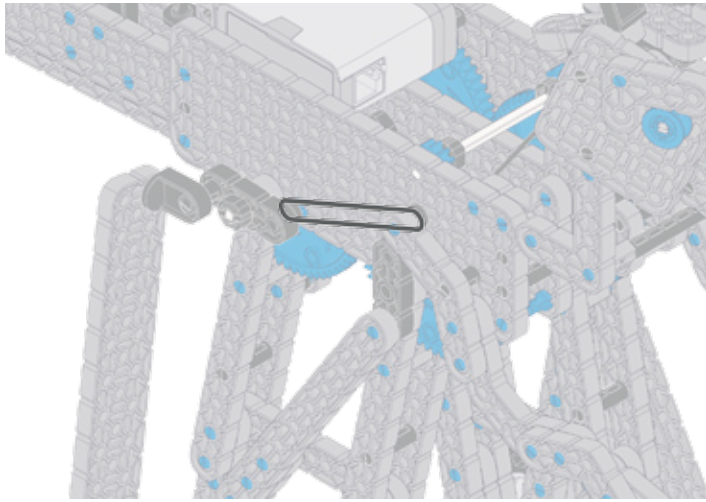
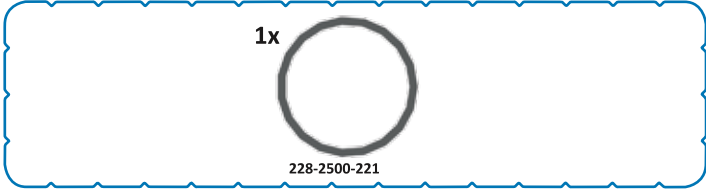

117

6x 228-2500-060

2x 228-2500-144

1x 228-2540

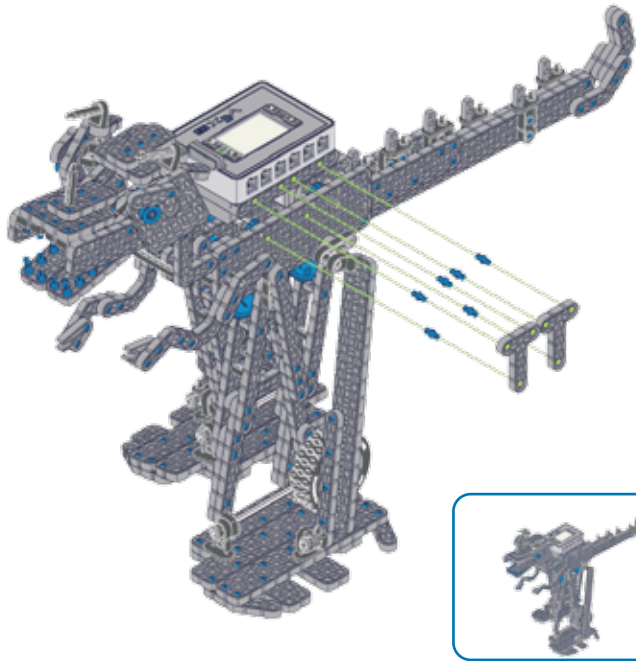

118

6x 228-2500-060

2x 228-2500-144

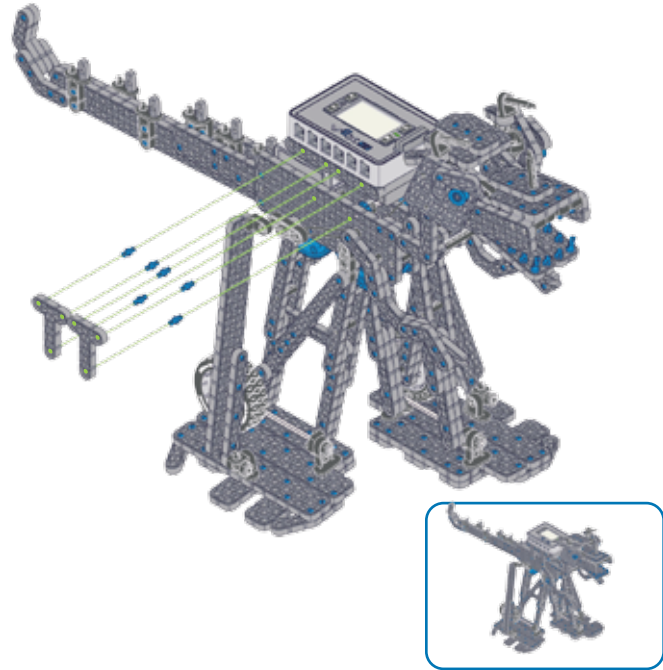

119

228-2780-001 200mm

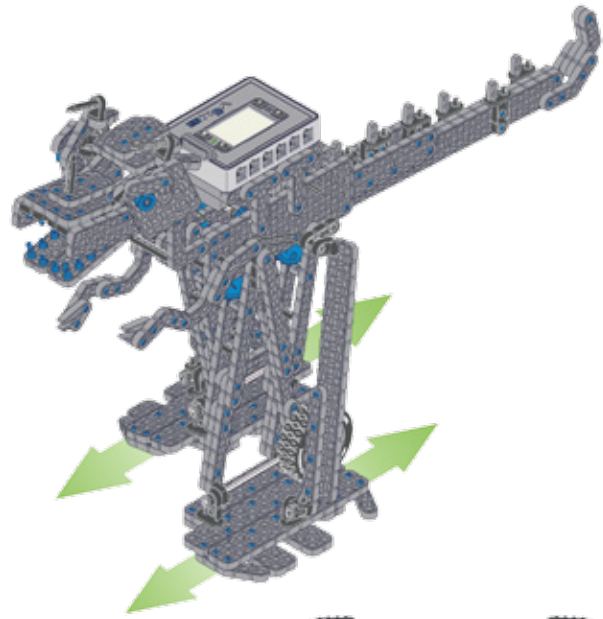
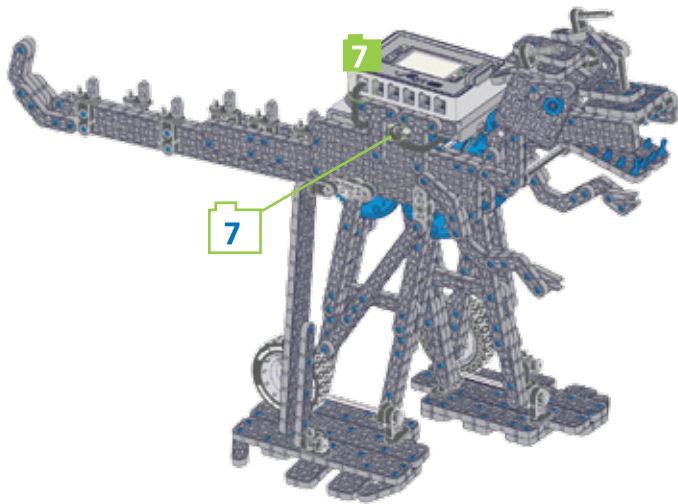

Вперед  
Назад



```

Programs
Driver Control
Autopilot
1
2
3
Select Settings
  
```



# Инструкция по сборке V-Rex

